

**ROOM FOR
IMAGINATION**

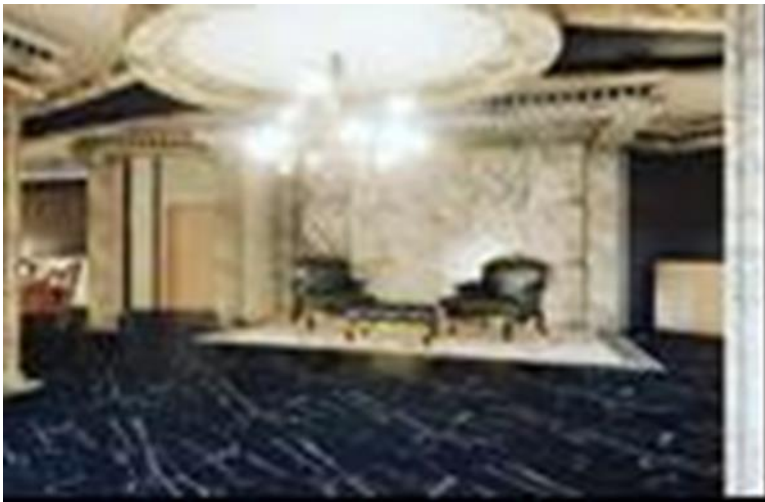

CATALOGO KAPPA 2022

Index by Alphabetical

A		M	
Amani Marble	32	Mare	218
Aquarela	198	Maremma	190
B		Medicea Marble	66
Bahia	38	N	
Basic Concrete	132	New Travertino	70
Black Beauty	42	P	
Blu Del Belgio	46	Panda Marble	74
C		R	
Calacatta Africa	52	Ripple	226
Calacatta Gold	56	S	
Cementina	140	Select Wood	124
Circle Wood	112	Sensation White	232
City Stone	166	Silk Marble	78
Classic	60	Spatula	238
Curton	172	Surface 2.0	146
D		Surface 2.0 Outdoor	156
Detroit Metal	92	T	
E		Taut	246
Evoque Metal	98	Tokyo Concrete	160
F		U	
Fabric Concrete	204	Urban Marble	82
I		V	
Icon Metal	104	Versilia Marble	86
L		W	
Line Wood	118	Wels	252
Loft Brick	210		
Lounge	180		
Luce	26		

Index by Look

Marble		Stone	
Amani Marble	32	City Stone	166
Bahia	38	Curton	172
Black Beauty	42	Lounge	180
Blu Del Belgio	46	Maremma	190
Calacatta Africa	52	Ceramic Wall Tiles	
Calacatta Gold	56	Aquarela	198
Classic	60	Fabric Concrete	204
Luce	26	Loft Brick	210
Medicea Marble	66	Mare	218
New Travertino	70	Sensation White	232
Panda Marble	74	Spatula	238
Silk Marble	78	Taut	246
Urban Marble	82	Ripple	226
Versilia Marble	86	Wels	252
Metal			
Detroit Metal	92		
Evoque Metal	98		
Icon Metal	104		
Wood			
Circle Wood	112		
Line Wood	118		
Select Wood	124		
Concrete			
Basic Concrete	132		
Cementina	140		
Surface 2.0	146		
Surface 2.0 Outdoor	156		
Tokyo Concrete	160		

Index by Sizes

120x260

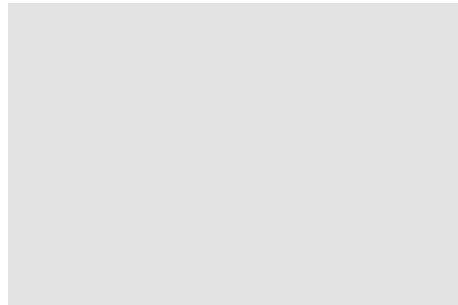

Bahia Wave Blue	38
Black Beauty	42
Blu Del Belgio Blue	46
Blu Del Belgio Clay	46
Calacatta Africa	52
Calacatta Gold	56
Classic Flurry	60
Classic New Marfil	60
Luce	26
Medicea Marble	66
New Travertino	70
Panda Marble	74
Silk Marble	78
Surface 2.0	146
Tokyo Concrete	160
Urban Marble	82
Versilia Marble	86

120x240

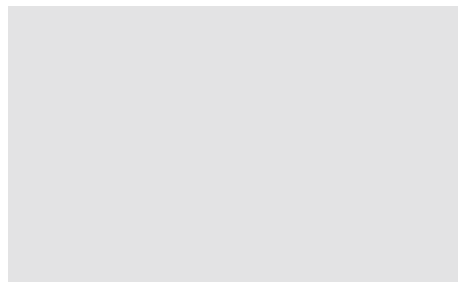

Amani Marble Light Grey	32
Amani Marble Brown	32
Icon Metal	104

y centroscomerciales en todo el mundo.

120x120

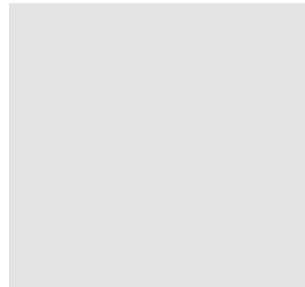

Amani Marble Light Grey	32
Amani Marble Brown	32
Blu Del Belgio Blue	46
Blu Del Belgio Clay	46
Calacatta Africa	52
Calacatta Gold	56
Classic New Marfil	60
Icon Metal	104
Medicea Marble	66
Surface 2.0	146
Versilia Marble	86

100x100

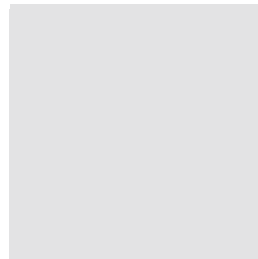

Lounge	180
--------	-----

75x75

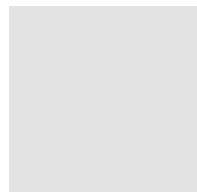

Basic Concrete	132
City Stone	166
Detroit Metal	92
Evoque Metal	98
Maremma	190
Surface 2.0	146

60x120

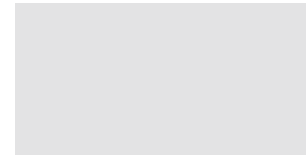

Amani Marble Light Grey	32
Bahia Wave Blue	38
Black Beauty	42
Blu Del Belgio Blue	46
Calacatta Africa	52
Calacatta Gold	56
Classic New Marfil	60
City Stone	166
Curton	172
Detroit Metal	92
Evoque Metal	98
Medicea Marble	66
Panda Marble	74
Silk Marble	78
Surface 2.0	146
Versilia Marble	86

60x60

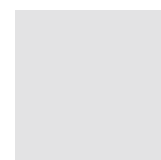

Cementina	132
City Stone	140
Curton	166
Lounge	172
Lounge	180
Surface 2.0	146
Surface 2.0 Outdoor	156

40x120



Taut	246
------	-----

30x100



Fabric Concrete	204
Wels	252

30x90

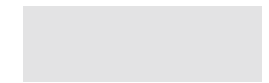

Aquarela	198
Mare	218
Spatula	238

30x60



Basic Concrete	132
City Stone	166
Lounge	180
Sensation White	232
Surface 2.0	146

25x90

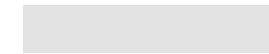

Ripple	226
--------	-----

19.5x120



Circle Wood	112
Line Wood	118
Select Wood	124

19.5x120



Line Wood	118
-----------	-----

6.5x26



Loft Brick	210
------------	-----



Marmo

Progetta i tuoi interni di lusso con un fascino senza tempo.

Una ampia e variegata gamma di collezioni ispirate all'eleganza del marmo, offre centinaia di soluzioni per spazi residenziali, hotel, ristoranti e luoghi di lavoro. Le venature dei classici effetti marmo e granito vengono riprodotte e rivisitate per rimodellare pareti, pavimenti, top ed elementi di arredo, creando ambienti sofisticati. Scegliendo una collezione effetto marmo, si sceglie la bellezza senza tempo di uno dei materiali più pregiati in natura, unendola a tutti i vantaggi del gres porcellanato in termini di prestazioni, durata e facilità di posa e manutenzione.



Marble

Design your luxury interiors with a timeless charm.

A wide and varied range of collections inspired by the elegance of marble to offer hundreds of solutions for residential areas, the hospitality industry and business places. Revised classy marble and granite patterns displaying elegant veins which remodel spaces, creating sophisticated ambiances. When you chose a Marble looking tile, you chose the timeless beauty of one of the finest materials in nature, combining it with all the advantages of porcelain and ceramic tiles in terms of performance, durability and ease of laying and maintenance.



Marbre

Projetez vos intérieurs de luxe avec une fascination intemporelle.

Une vaste gamme variée de collections s'inspirant à l'élégance du marbre, offre des centaines de solutions pour les espaces résidentiels, les hôtels, les restaurants et les lieux de travail. Les veines des effets classiques du marbre et de granit sont reproduites et réinterprétées, pour modérer des murs, des sols, des plans de travail et des éléments d'ameublement, créant des espaces sophistiqués. En choisissant une collection marbre, on choisit la beauté intemporelle d'un des matériaux les plus précieux de la nature, en l'unissant à tous les avantages du grès porcelaine, en ce qui concerne les prestations, la durabilité et la facilité de la pose et de la maintenance.



Mármol

Diseña tus interiores de lujo con un encanto atemporal.

Una amplia y variada gama de colecciones inspiradas en la elegancia del mármol que permite ofrecer cientos de soluciones para áreas residenciales, sector de la hostelería y establecimientos comerciales. Patrones refinados de granito y mármol actualizados que muestran las vetas elegantes que remodelan sus espacios, creando ambientes sofisticados. Al elegir la colección de baldosas de aspecto mármol, se está eligiendo la belleza atemporal de uno de los materiales naturales más elegantes, junto con todos los beneficios de las baldosas de cerámica y porcelana en términos de rendimiento, durabilidad y facilidad de colocación y mantenimiento.

Infinite possibilita'

Immagina uno spazio continuo senza fughe. Immagina infinite possibilita' per il rivestimento di ogni tipo di superficie, con una totale versatilita' per ogni tipologia di applicazione. Maximus è disponibile in 3 differenti spessori ed una vasta gamma di formati e finiture. Resistente al calore, riciclabile, leggero, durevole e facile da pulire. Maximus e' la risposta piu' innovativa alle sempre piu' ambiziose esigenze di progettisti ed interior designers.



The design possibilities are endless

Imagine a tiled space with virtually no grout lines. Imagine limitless possibilities for your surfaces and unparalleled flexibility for any kind of applications. Maximus is available in 3 thicknesses and a wide range of finishes and sizes. Heat resistance, recyclable, light weight, durable and easy to clean. Maximus is the best answer to the most challenging architectural and interior design needs.



Des possibilités infinies

Imaginez un espace continu sans joints. Imaginez une infinité de possibilités pour le revêtement de tout type de surfaces, avec une versatilité complète pour toute typologie d'application. Maximus est disponible en 3 différentes épaisseurs et en une vaste gamme de formats et de finitions. Résistant à la chaleur, recyclable, léger, durable et facile à nettoyer. Maximus est la réponse la plus innovante aux exigences de plus en plus ambitieuses de concepteurs et de designers d'intérieur.



Las posibilidades de diseño son infinitas

Imagine un espacio de azulejos sin líneas de la boquilla. Imagine posibilidades ilimitadas para sus superficies y una flexibilidad inigualable para cualquier tipo de aplicaciones. Maximus está disponible en 3 espesores y en una amplia gama de acabados y tamaños. Resistencia al calor, reciclable, ligero, duradero y fácil de limpiar. Maximus es la mejor respuesta a las necesidades de diseño arquitectónico y de interiores más desafiantes.

120x260 cm
47.24"x102.36"

>| 6 mm

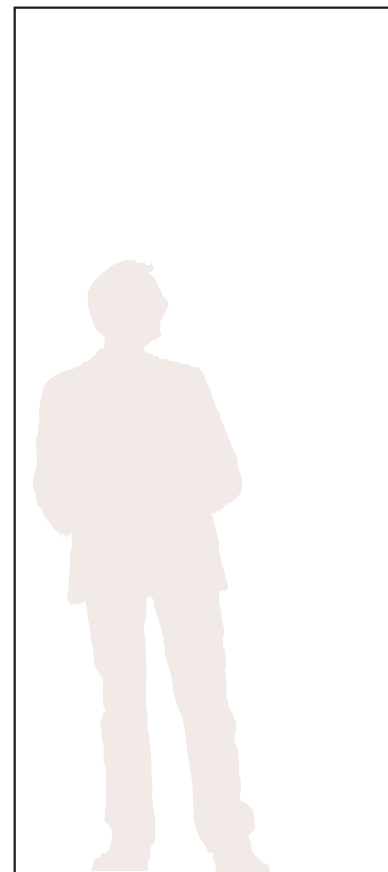

120x240 cm
47.24"x94.48"

>| 6 mm

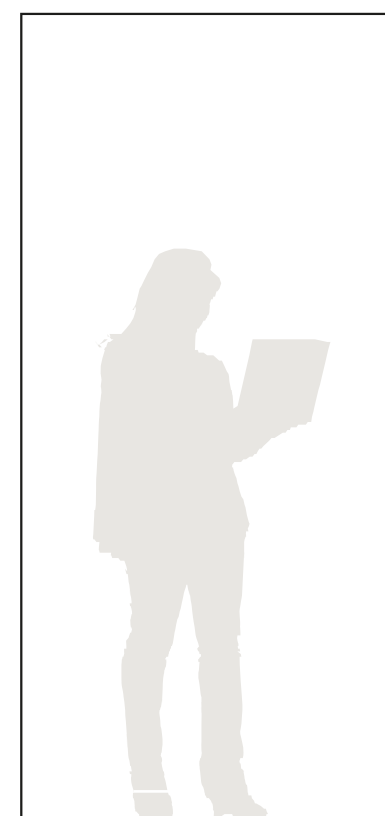

120x120 cm
47.24"x47.24"

>| 9 mm

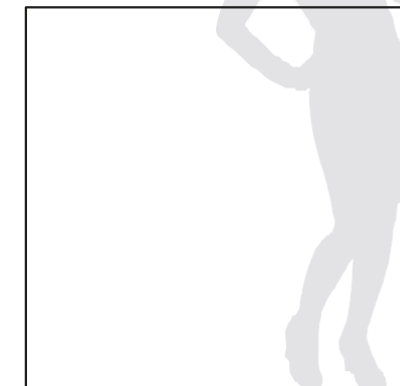

60x120 cm
23.62"x47.24"

>| 9 mm

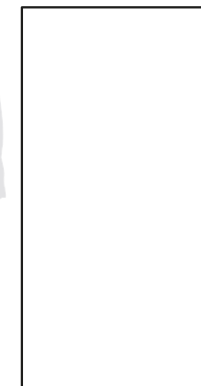

MAXIMUS
MEGA SLAB

Versatile e semplicemente bellissime, le lastre Maximus rivoluzionano il mondo dell'architettura e dell'interior design, aprendo nuove prospettive ad applicazioni fino ad ora inimmaginabili. Tutte le superfici continue sono disegnate per ogni tipo di applicazione: pareti e pavimenti, facciate esterne, mobili e piani di lavoro e garantiscono flessibilità creativa e prestazioni tecniche ed estetiche di altissimo livello.



Versatile and simply beautiful, the Maximus slab revolutionises the design and architecture world by opening up new perspectives in tile application that were previously unimaginable. All the continuous surfaces are designed for any type of application: floor and walls, cladding, furnishing, countertops and provide creative flexibility and high technical and aesthetic performances.



Versatiles et tout simplement beaux, les carreaux Maximus révolutionnent le monde de l'architecture et du design d'intérieur, ouvrant de nouvelles perspectives aux applications jusqu'ici inimaginables. Toutes les surfaces continues sont conçues pour tout type d'application: murs et sols, façades extérieures, meubles et plans de travail, et garantissent une flexibilité créative ainsi que des prestations techniques et esthétiques de niveau très élevé.



Versátiles y simplemente bonitas, la baldosa Maximus revoluciona el mundo del diseño y la arquitectura al abrir nuevas perspectivas en aplicación de baldosas que eran inimaginables. Todas las superficies continuas están diseñadas para cualquier tipo de aplicación: suelo y paredes, revestimientos, mobiliario, encimeras y proporcionan flexibilidad creativa y altas prestaciones técnicas y estéticas.



PARETI E FACCIATE

Walls and Facade
Murs et façades
Paredes y Fachada

PIANI DI LAVORO

Countertop Surfaces
Plans de travail
Superficies de Mostrador

MOBILI

Furniture
Meubles
Meubles

PAVIMENTI

Floor
Sols
Suelo

MAXIMUS
MEGA SLAB



Furniture: Luce Marble Onyx Acro Red

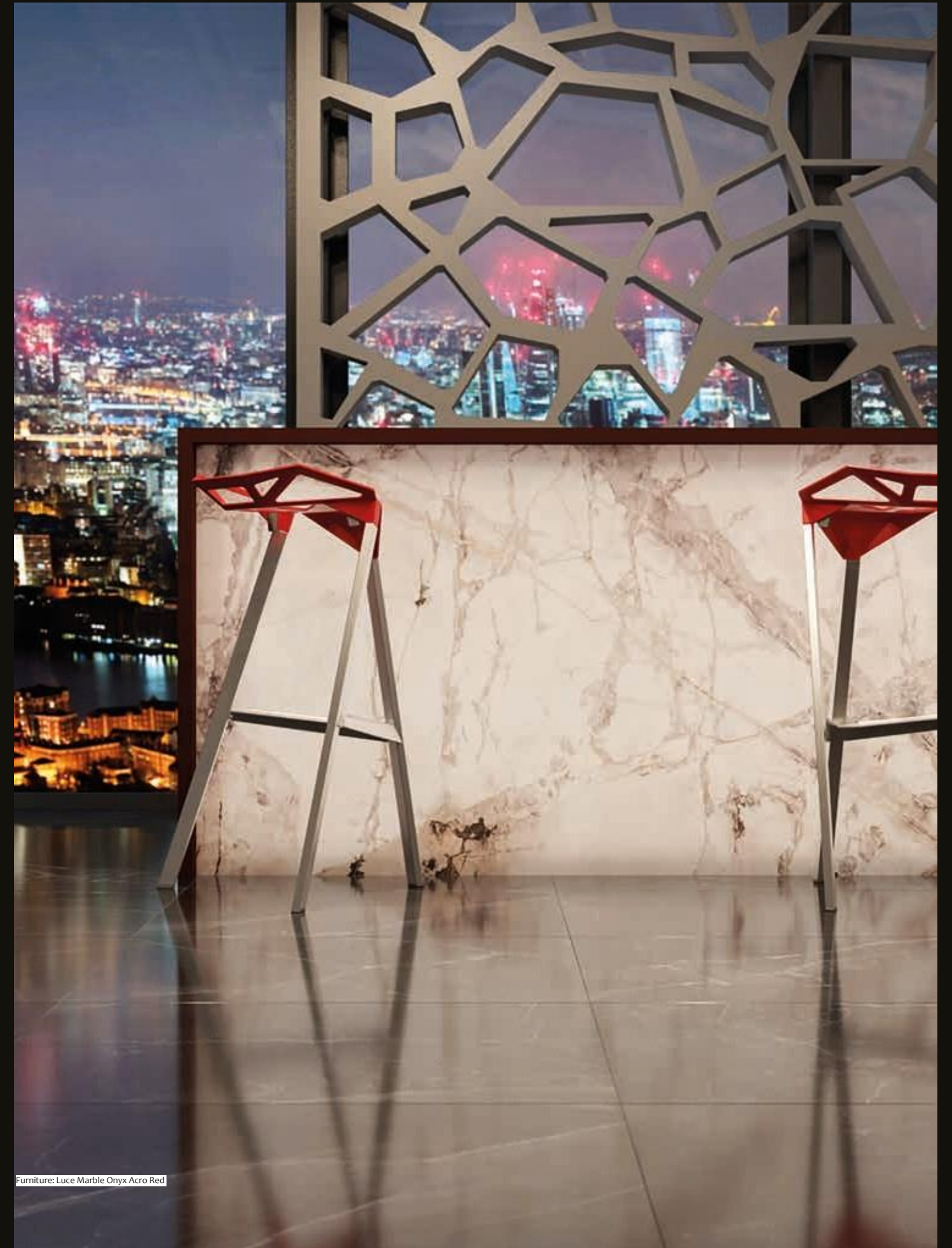

Furniture: Luce Marble Onyx Acro Red

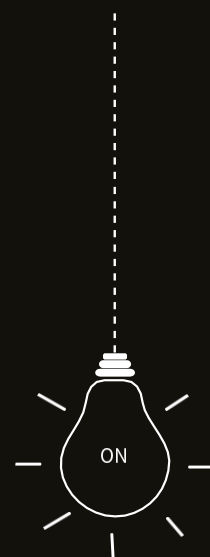

LUCE

La luce diventa un vero e proprio strumento nelle mani del designer e attraverso superfici eleganti arricchisce gli ambienti rendendoli magici.

Questo è ciò che rende le nuove lastre Maximus Luce uno strumento fondamentale per sviluppare il tuo concetto di design, con una nuova e straordinaria tecnologia di retroilluminazione della lastra. Una novità assoluta capace di ispirare la tua creatività.

8 differenti grafiche e colorazioni in effetto marmo e onice, che replicano la naturale capacità delle pietre di filtrare la luce.

Ideale per scenografici hotel, ristoranti, uffici, negozi e ambienti residenziali sofisticati. Illumina i tuoi progetti con Maximus Luce.

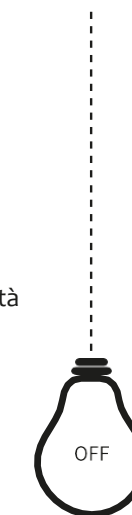

Luce

Light becomes a design tool in the hands of the designer and through elegant surfaces it enriches environment's, making them magical.

This is what makes the new Maximus Luce slabs a stunning centerpiece for your design concept with amazing backlighting technology. An absolute novelty that will inspire your creativity.

8 different graphics and colours in marble and onyx effect, that replicate the natural ability of the stones to filter light.

Can be used in hotels, restaurants, offices, shops and sophisticated residential environments. Light up your projects with Maximus Luce.



Lumière

La lumière devient un vrai et propre instrument entre les mains du designer et enrichit les espaces, par les surfaces élégantes, en les rendant magiques.

C'est ce qui fait des nouveaux carreaux Maximus Luce un instrument fondamental, pour développer votre concept de design, par une nouvelle technologie extraordinaire de rétro-illumination du carreau. Une nouveauté absolue à même d'inspirer votre créativité.

8 différentes graphiques et colorations en effet marbre et onyx, qui reproduisent la capacité naturelle des pierres de filtrer la lumière.

Idéal pour les hôtels scénographiques, restaurants, bureaux, magasins et espaces résidentiels sophistiqués. Illuminez vos projets par Maximus Luce.



Luz

La luz se convierte en una verdadera herramienta en las manos del diseñador y a través de elegantes superficies enriquece los ambientes haciéndolos mágicos.

Esto es lo que hace que las nuevas losas Maximus Luce sean una herramienta esencial para desarrollar tu concepto de diseño, con una nueva y extraordinaria tecnología de retroiluminación de la misma. Una novedad absoluta capaz de inspirar tu creatividad.

8 gráficos y colores diferentes en efecto mármol y ónice, que replican la capacidad natural de las piedras para filtrar la luz.

Ideal para hoteles panorámicos, restaurantes, oficinas, tiendas y ambientes residenciales sofisticados. Ilumina tus proyectos con Maximus Luce.



luce onyx white



luce onyx harlequin



luce onyx green jade



luce onyx azul



luce onyx ivory



luce onyx arco red



luce marble white

Formati | Sizes | Formats | Formatos

120x260 cm

>| 6 mm

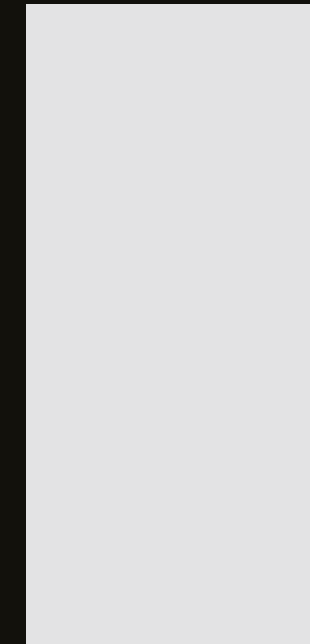

Price Codes

Formato(CM)	Full Lappato
120x260	A50

Nome	Spessore (MM)	Codice (Full Lappato)	Formato (CM)
luce onyx white	6	ATB62LUCEONYZHSC6P	120x260
luce onyx harlequin	6	ATB62LUCEOHNZHSC6P	120x260
luce onyx green jade	6	A62CLUCE-OGJ.NoX6P	120x260
luce bahia azul	6	ATB62LUCEBAZZHSC6P	120x260
luce onyx ivory	6	ATB62LUCEOIVZHSC6P	120x260
luce onyx arco red	6	ATB62LUCEOARZHSC6P	120x260
luce marble white	6	ATB62LUCEMARZHSC6P	120x260

Formato (cm)	Spessore (mm)	Pezzi X	M ² X	Kg X	X Eu. Pallet	M ² X Eu. Pallet	kg X Eu. Pallet
120X260	9	5	1.17	25.00	36	42.12	921.00

Amani Marble

MAXIMUS
MEGA SLAB



Wall: Amani Marble Light Grey
Floor: Amani Marble Brown



Wall and Floor: Amani Marble Light Grey

MAXIMUS
MEGA SLAB

Amani Marble



Wall: Amani Marble Light Grey
Floor: Amani Marble Brown



*amani marble light grey



amani marble brown

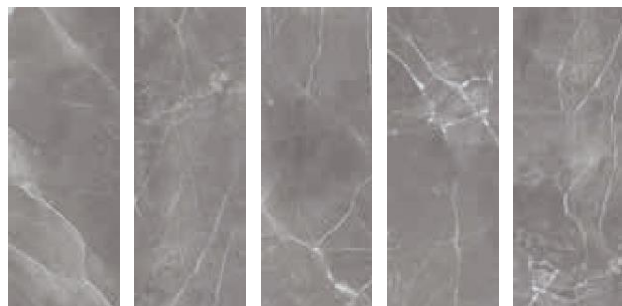

amani marble light grey variations
120x240

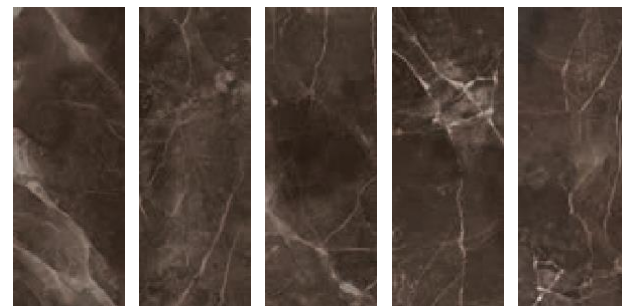

amani marble brown variations
120x240

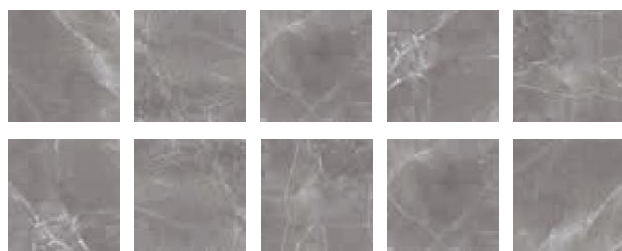

amani marble light grey variations
120x120

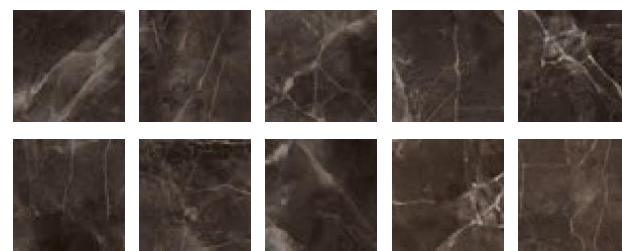

amani marble brown variations
120x120

Formati | Sizes | Formats | Formatos

120x240 cm
>| 6 mm

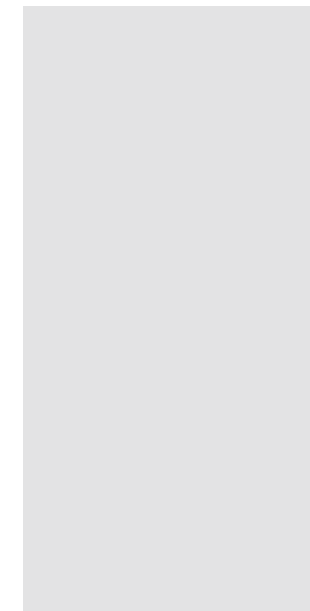

120x120 cm
>| 9 mm

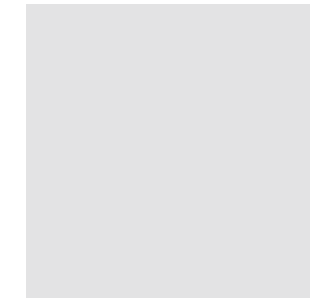

*60x120 cm
>| 9 mm

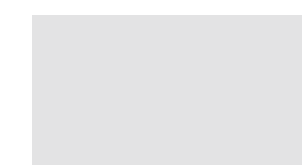

*Only available for: amani marble light grey

Finiture | Finishes | Finitions | Acabados



full lappato



*natural



Price Codes

Formato(CM)	Natural	Full Lappato
120x240	-	A35
120x120	-	A21
60x120	A10	A10

Nome	Spessore (MM)	Codice (Full Lappato)	Formato (CM)
amani marble light grey	6	AGB46AMMBLIGZHSC6P	120x240
amani marble light grey	9	AGB22AMMBLIGZHSC3P	120x120
amani marble light grey	9	AGB12AMMBLIGZHSS5P	60x120

Nome	Spessore (MM)	Codice (Natural)	Formato (CM)
amani marble light grey	9	A12GAMMB-LIG.OoX5P	60x120

Nome	Spessore (MM)	Codice (Full lappato)	Formato (CM)
amani marble brown	6	AGB46AMMBBRNZHSC6P	120x240
amani marble brown	9	AGB22AMMBBRNZHSC3P	120x120

Formato (cm)	Spessore (mm)	Pezzi X	M² X	Kg X	X Eu. Pallet	M² X Eu. Pallet	kg X Eu. Pallet
120x240	6	1	2.88	43.50	24	69.12	1044.00
120x120	9	2	2.88	60.00	22	63.36	1320.00
60x120	9	2	1.44	32.00	28	40.32	896.00

MAXIMUS
MEGA SLAB

Bahia



Furniture: Bahia Wave Blue



bahia wave blue



bahia wave blue variations
120x260

Formati | Sizes | Formats | Formatos

120x260 cm
>| 6 mm

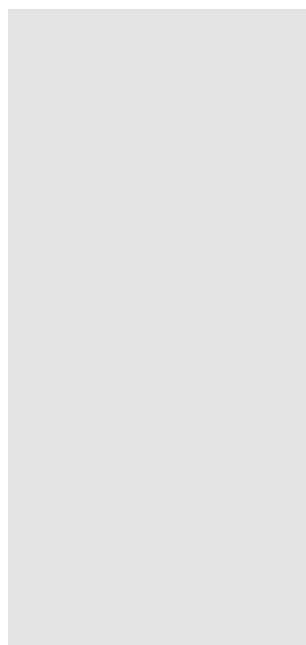

60x120 cm
>| 9 mm

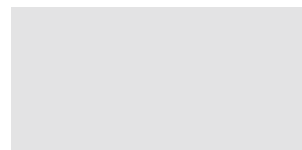

Price Codes

Formato(CM)	Full Lappato
120x260	A39
60x120	A13



Furniture: Bahia Wave Blue

Nome	Spessore (MM)	Codice (Full Lappato)	Formato (CM)
bahia wave	6	A62GBHWE-BLE.NoX6P	120x260
bahia wave	9	AGB12BHWEBLEZHSS5P	60x120

Formato (cm)	Spessore (mm)	Pezzi X	M' X	Kg X	X Eu. Pallet	M' X Eu. Pallet	kg X Eu. Pallet
120x260	6	1	3.12	48.00	20	62.40	960.00
60x120	9	2	1.44	32.00	28	40.32	896.00

MAXIMUS
MEGA SLAB

Black Beauty

MARMO

Wall: Black Beauty

Black Beauty

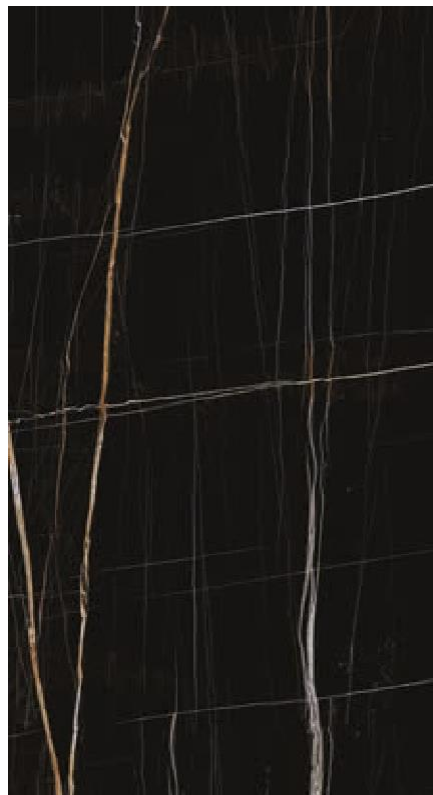

black beauty

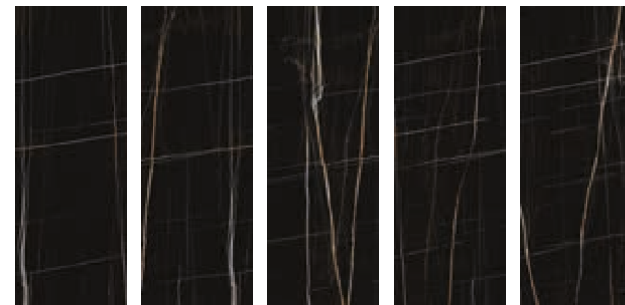

black beauty variations
120x260

Formati | Sizes | Formats | Formatos

120x260 cm

>| 6 mm

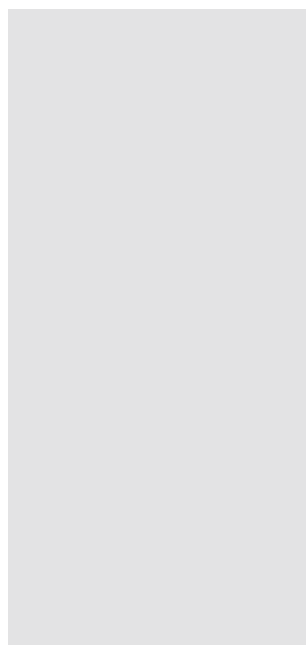

60x120 cm

>| 9 mm

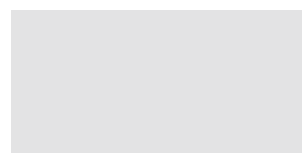

Price Codes

Formato(CM)	Full Lappato
120x260	A39
60x120	A13



Wall: Black Beauty

Nome	Spessore (MM)	Codice (Full Lappato)	Formato (CM)
black beauty	6	A62GBBKB-NEO.NoX6P	120x260
black beauty	9	AGB12BBKBNEOZH5C3P	60x120

Formato (cm)	Spessore (mm)	Pezzi X	M' X	Kg X	X Eu. Pallet	M' X Eu. Pallet	kg X Eu. Pallet
120x260	6	1	3.12	48.00	20	62.40	960.00
60x120	9	2	1.44	32.00	28	40.32	896.00

MARMO

Blu Del Belgio

MAXIMUS
MEGA SLAB



Floor: Blu Del Belgio Clay 120x120 cm

Blu Del Belgio



Floor: Blu Del Belgio Blue 120x260 cm

MAXIMUS
MEGA SLAB

Blu Del Belgio



Wall: Blu Del Belgio Blue 120x260 cm
Floor: Blu Del Belgio Clay 120x120 cm

Blu Del Belgio



*blu del belgio blue



blu del belgio clay



blu del belgio blue variations
120x260



blu del belgio clay variations
120x260

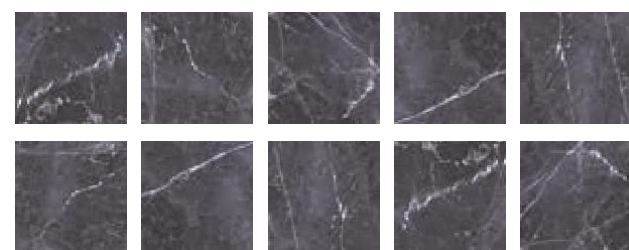

blu del belgio blue variations
120x120



blu del belgio clay variations
120x120

Formati | Sizes | Formats | Formatos

120x260 cm

>| 6 mm



120x120 cm

>| 9 mm

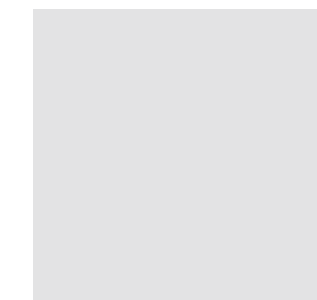

*60x120 cm

>| 9 mm



*Only available for: blu del belgio blue

Price Codes

Formato(CM)	Full Lappato
120x260	A36
120x120	A24
60x120	A13

Nome	Spessore (MM)	Codice (Full Lappato)	Formato (CM)
blu del belgio blue	6	A62GZBLB-BLo.GoC6P	120x260
blu del belgio blue	9	A122GBLB-BLo.GoC3P	120x120
blu del belgio blue	9	AGB12ZBLBBLEZGSS5P	60x120

Nome	Spessore (MM)	Codice (Full Lappato)	Formato (CM)
blu del belgio clay	6	A62GZBLB-CLo.GoC6P	120x260
blu del belgio clay	9	A122GBLB-CLo.GoC3P	120x120

Formato (cm)	Spessore (mm)	Pezzi X	M ² X	Kg X	X Eu. Pallet	M ² X Eu. Pallet	kg X Eu. Pallet
120x260	6	1	3.12	48.00	20	62.40	960.00
120x120	9	2	2.88	60.00	22	63.36	1320.00
60x120	9	2	1.44	32.00	28	40.32	896.00

MAXIMUS
MEGA SLAB

Calacatta Africa



Wall: Calacatta Africa White

Calacatta Africa



calacatta africa white

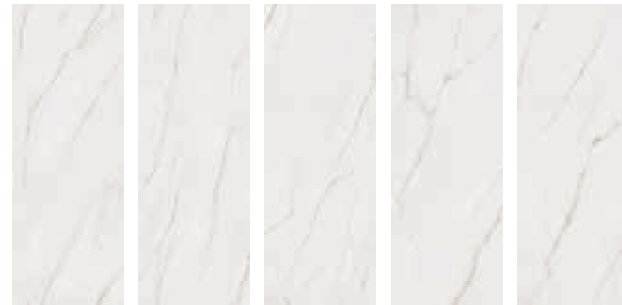

calacatta africa white variations
120x260

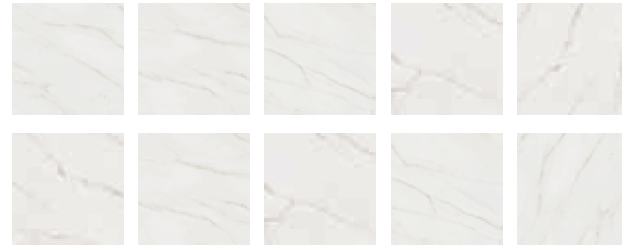

calacatta africa white variations
120x120

Formati | Sizes | Formats | Formatos

120x260 cm
>| 6 mm

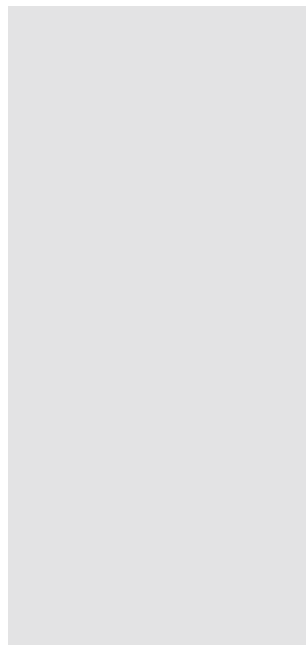

120x120 cm
>| 9 mm

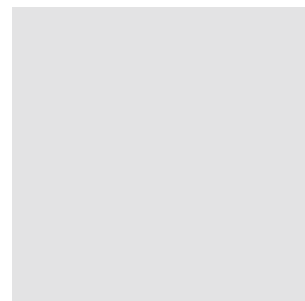

60x120 cm
>| 9 mm

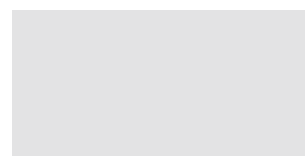

Finiture | Finishes | Finitions | Acabados

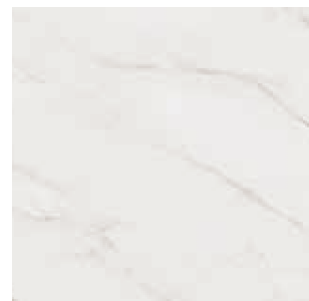

full lappato

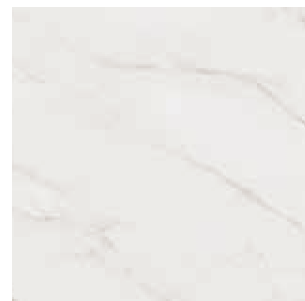

natural



Price Codes

Formato(CM)	Natural	Full Lappato
120x260	A36	A36
120x120	A21	A21
60x120	A10	A10



Wall and Floor: Calacatta Africa White

Nome	Spessore (MM)	Codice (Full Lappato)	Formato (CM)
calacatta africa white	6	A62GCCAF-WHE.NoX6P	120x260
calacatta africa white	9	AGB22CCAFWHEZHSC3P	120x120
calacatta africa white	9	AGB12CCAFWHEZHSS5P	60x120

Nome	Spessore (MM)	Codice (Natural)	Formato (CM)
calacatta africa white	6	A62GCCAF-WHE.MoX6R	120x260
calacatta africa white	9	A22GCCAF-WHE.MoX5R	120x120
calacatta africa white	9	A12GCCAF-WHE.MoX5R	60x120

Formato (cm)	Spessore (mm)	Pezzi X	M ² X	Kg X	X Eu. Pallet	M ² X Eu. Pallet	kg X Eu. Pallet
120x260	6	1	3.12	48.00	20	62.40	960.00
120x120	9	2	2.88	60.00	22	63.36	1320.00
60x120	9	2	1.44	32.00	28	40.32	896.00

MAXIMUS
MEGA SLAB

Calacatta Gold



Wall: Calacatta Gold

Calacatta Gold



calacatta gold white



calacatta gold white variations
120x260

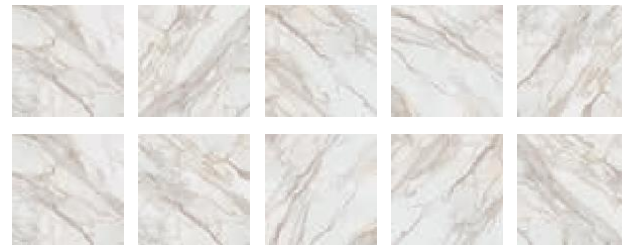

calacatta gold white variations
120x120

Formati | Sizes | Formats | Formatos

120x260 cm
>| 6 mm

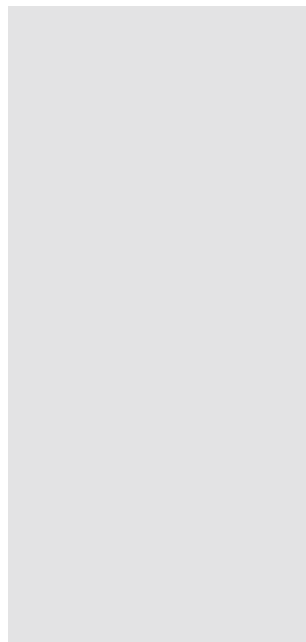

120x120 cm
>| 9 mm

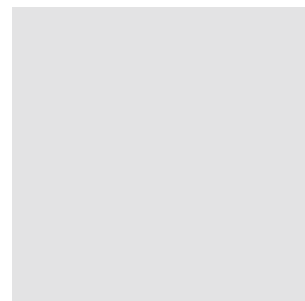

60x120 cm
>| 9 mm

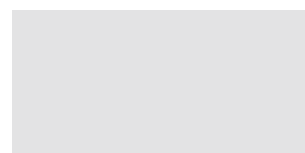

Finiture | Finishes | Finitions | Acabados



full lappato



natural



Price Codes

Formato(CM)	Natural	Full Lappato
120x260	A36	A36
120x120	A21	A21
60x120	A10	A10

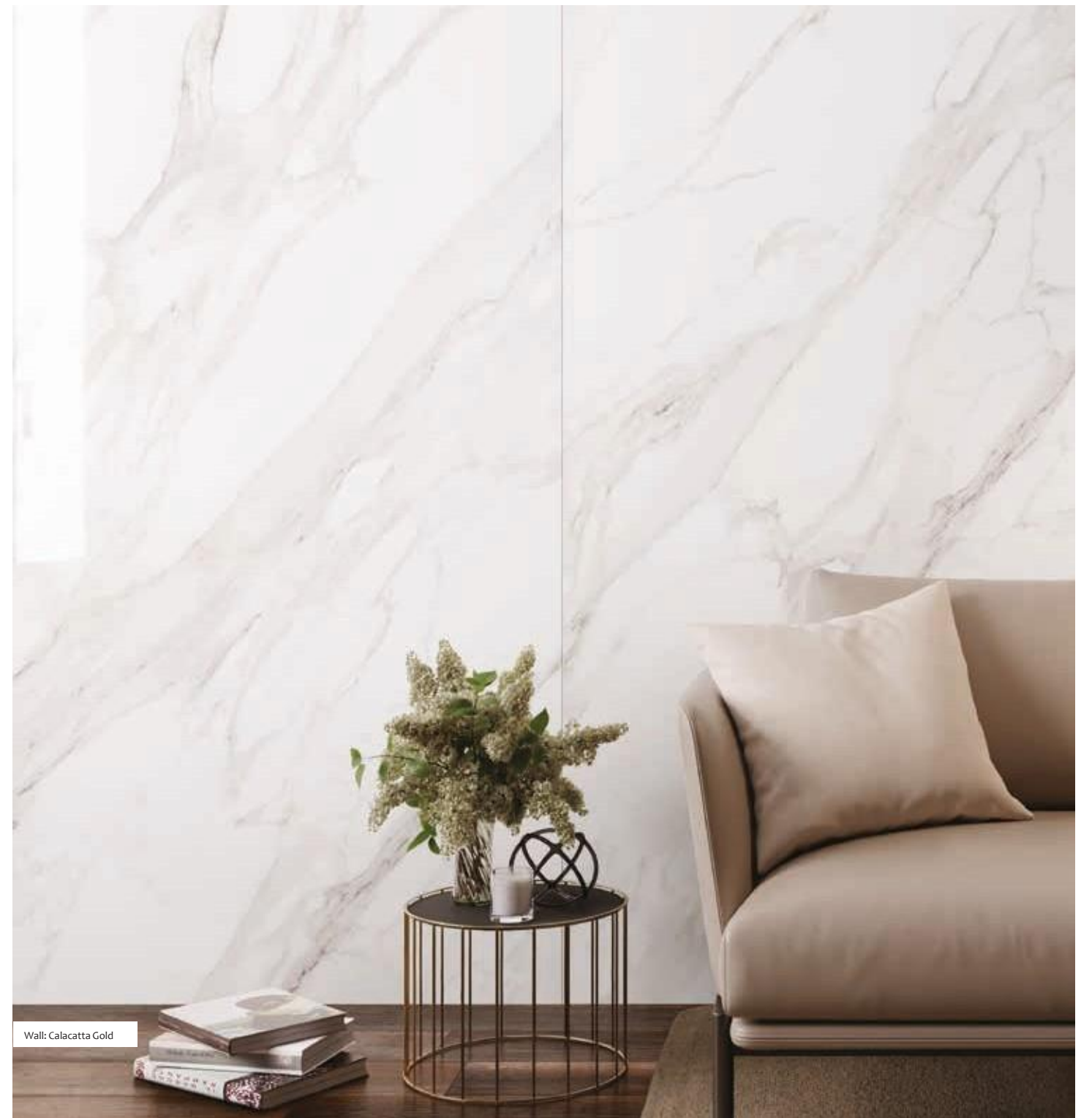

Wall: Calacatta Gold

Nome	Spessore (MM)	Codice (Full Lappato)	Formato (CM)
calacatta gold	6	A62GCTAG-WHE.NoX6P	120x260
calacatta gold	9	AGB22CTAGWHEZHSC3P	120x120
calacatta gold	9	AGB12CTAGWHEZHSS5P	60x120

Nome	Spessore (MM)	Codice (Natural)	Formato (CM)
calacatta gold	6	A62GCTAG-WHE.MoX6R	120x260
calacatta gold	9	A22GCTAG-WHE.MoX5R	120x120
calacatta gold	9	A12GCTAG-WHE.MoX5R	60x120

Formato (cm)	Spessore (mm)	Pezzi X	M ² X	Kg X	X Eu. Pallet	M ² X Eu. Pallet	kg X Eu. Pallet
120x260	6	1	3.12	48.00	20	62.40	960.00
120x120	9	2	2.88	60.00	22	63.36	1320.00
60x120	9	2	1.44	32.00	28	40.32	896.00

Classic

MAXIMUS
MEGA SLAB

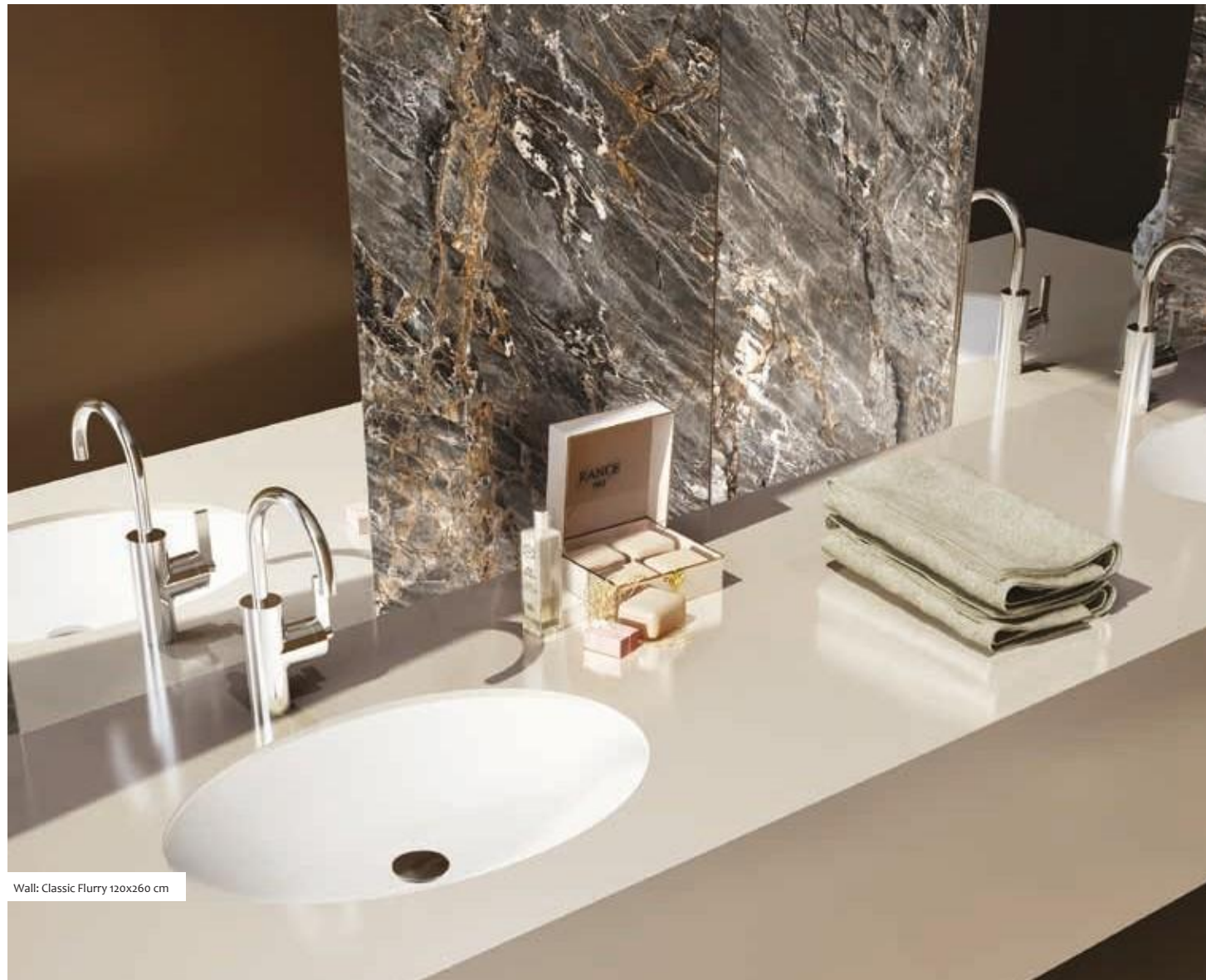

Wall: Classic Flurry 120x260 cm



Wall and Floor: New Marfil

MAXIMUS
MEGA SLAB

Classic



Wall: Classic New Marfil
Floor: Classic New Marfil
Kitchen Countertop: Classic New Marfil



classic flurry



*classic new marfil

Formati | Sizes | Formats | Formatos

120x260 cm
>| 6 mm

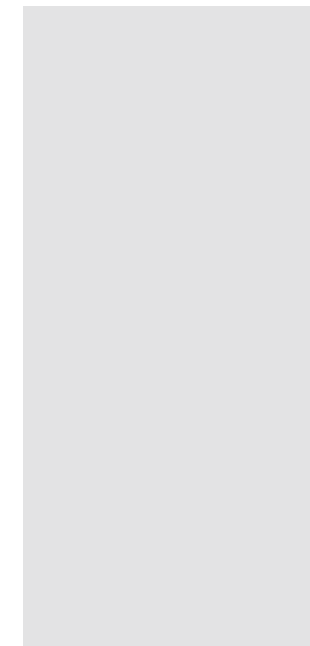

*120x120 cm
>| 9 mm

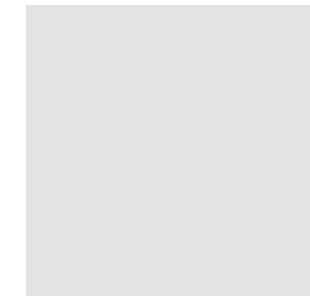

*60x120 cm
>| 9 mm

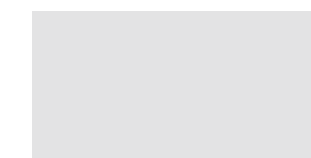

*Only available for: classic new marfil

Price Codes

Formato (CM)	Full Lappato
120x260	A36
120x120	A21
60x120	A10

Nome	Spessore (MM)	Codice (Full Lappato)	Formato (CM)
classic flurry	6	A62GZFLU-GYo.GoC6P	120x260
classic new marfil	6	A62GZNMFBEO.GoC6P	120x260
classic new marfil	9	A122GZNMFBEO.GoC3P	120x120
classic new marfil	9	AGB12ZNMFBEEZGSS5P	60x120

Formato (cm)	Spessore (mm)	Pezzi X	M ² X	Kg X	X Eu. Pallet	M ² X Eu. Pallet	kg X Eu. Pallet
120x260	6	1	3.12	48.00	20	62.40	960.00
120x120	9	2	2.88	60.00	22	63.36	1320.00
60x120	9	2	1.44	32.00	28	40.32	896.00

MAXIMUS
MEGA SLAB

Medicea Marble

MARMO

Wall: Medicea Marble White
Furniture: Medicea Marble Hyper White

Medicea Marble



medicea marble white



medicea marble white variations
120x260

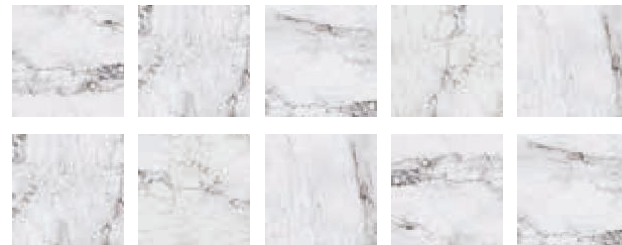

medicea marble white variations
120x120

Formati | Sizes | Formats | Formatos

120x260 cm
>| 6 mm

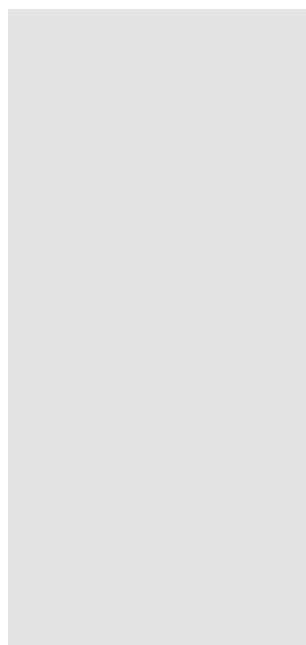

120x120 cm
>| 9 mm

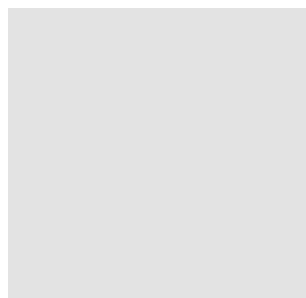

60x120 cm
>| 9 mm

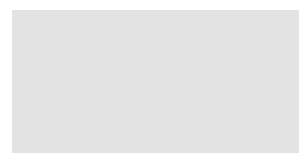

Price Codes

Formato(CM)	Full Lappato
120x260	A36
120x120	A21
60x120	A10



Wall: Medicea Marble White
Countertop: Medicea Marble Hyper White

Nome	Spessore (MM)	Codice (Full Lappato)	Formato
medicea marble white	6	AGB62MDBWHEZHSC6P	120x260
medicea marble white	9	AGB22MDBWHEZHSC3P	120x120
medicea marble white	9	AGB12MDBWHEZHSS5P	60x120

Formato (cm)	Spessore (mm)	Pezzi X	M' X	Kg X	X Eu. Pallet	M' X Eu. Pallet	kg X Eu. Pallet
120x260	6	1	3.12	48.00	20	62.40	960.00
120x120	9	2	2.88	60.00	22	63.36	1320.00
60x120	9	2	1.44	32.00	28	40.32	896.00



Wall: New Travertino Ivory 120x260 cm

New Travertino



new travertino ivory



new travertino brown

Formati | Sizes | Formats | Formatos

120x260 cm

>| 6 mm

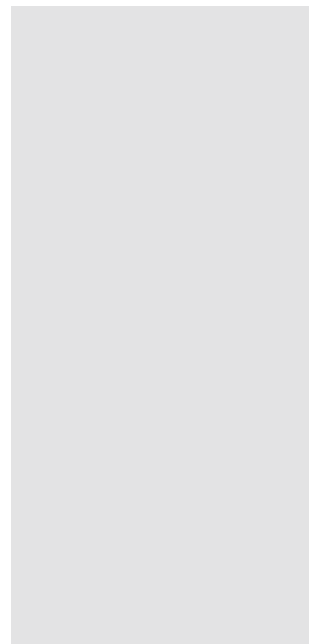

Price Codes

Formato(CM)	Full Lappato
120x260	A36

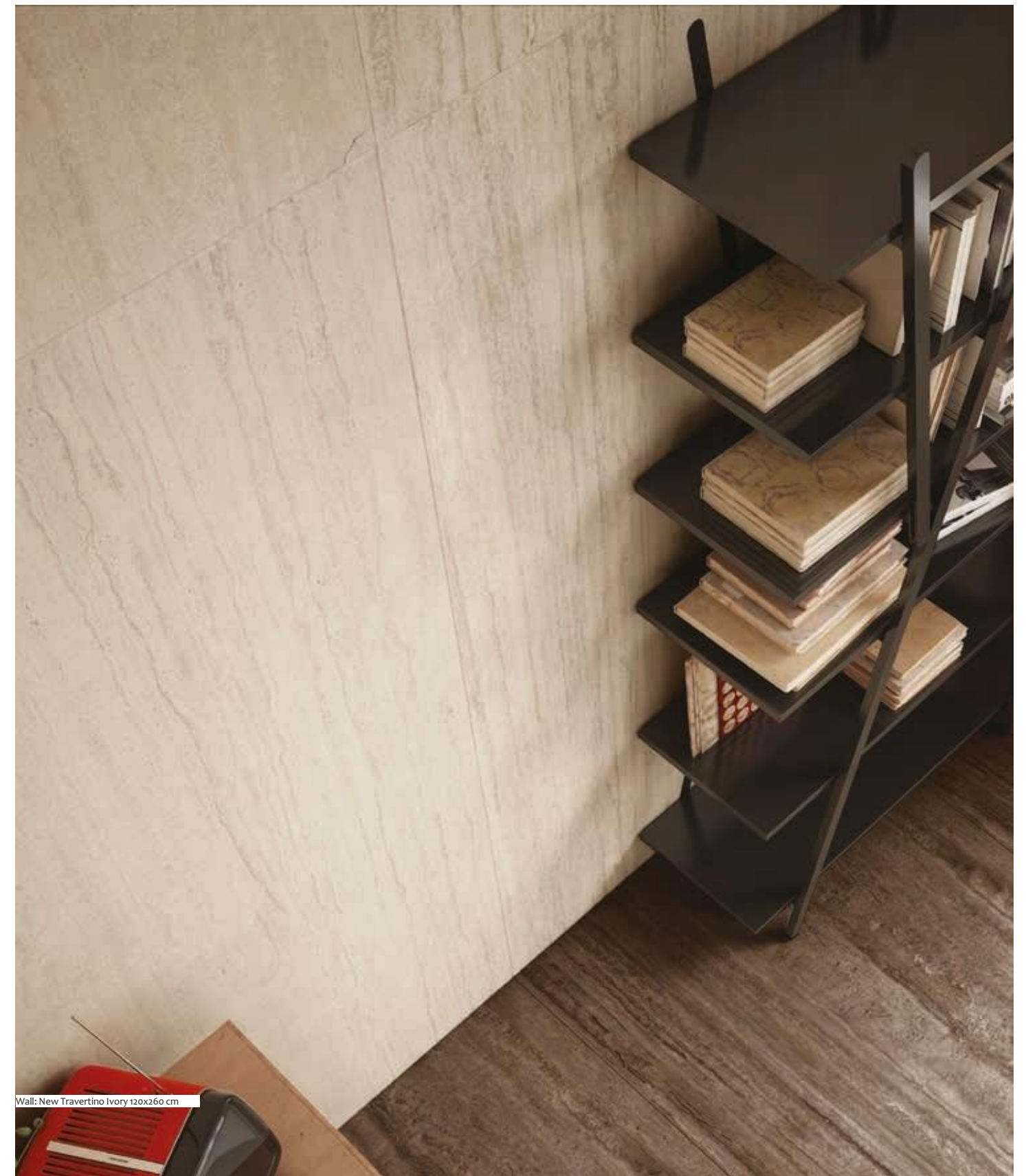

Wall: New Travertino Ivory 120x260 cm

Nome	Spessore (MM)	Codice (Full Lappato)	Formato (CM)
new travertino ivory	6	A62GZNTV-IVo.GoC6P	120x260
new travertino brown	6	A62GZNTV-BRo.GoC6P	120x260

Formato (cm)	Spessore (mm)	Pezzi X	M ² X	Kg X	X Eu. Pallet	M ² X Eu. Pallet	kg X Eu. Pallet
120x260	6	1	3.12	48.00	20	62.40	960.00

MAXIMUS
MEGA SLAB

Panda Marble



Wall: Panda Marble White

Panda Marble



panda marble white



panda marble white variations
120x260

Formati | Sizes | Formats | Formatos

120x260 cm

>| 6 mm

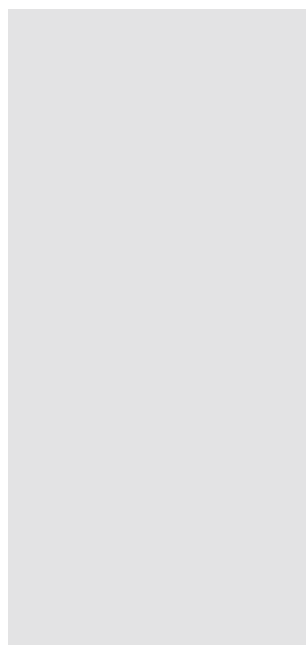

60x120 cm

>| 9 mm

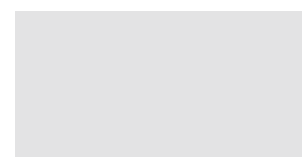

Price Codes

Formato(CM)	Full Lappato
120x260	A36
60x120	A10



Wall and Floor: Panda Marble White

Nome	Spessore (MM)	Codice (Full Lappato)	Formato (CM)
panda marble white	6	AGB62PDMBWHEZHSC6P	120x260
panda marble white	9	AGB12PDMBWHEZHSS5P	60x120

Formato (cm)	Spessore (mm)	Pezzi X	M² X	Kg X	X Eu. Pallet	M² X Eu. Pallet	kg X Eu. Pallet
120x260	6	1	3.12	48.00	20	62.40	960.00
60x120	9	2	1.44	32.00	28	40.32	896.00

MAXIMUS
MEGA SLAB

Silk Marble



Wall and Floor: Silk Marble Grey

Silk Marble



silk marble grey

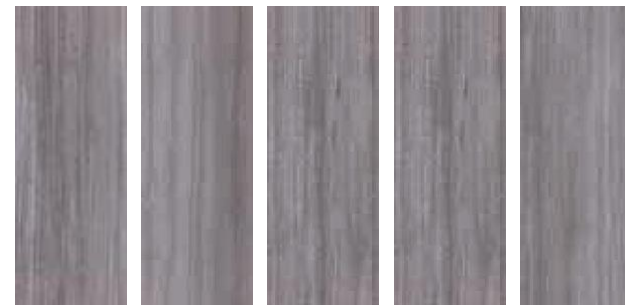

silk marble grey variations
120x260

Formati | Sizes | Formats | Formatos

120x260 cm

>| 6 mm

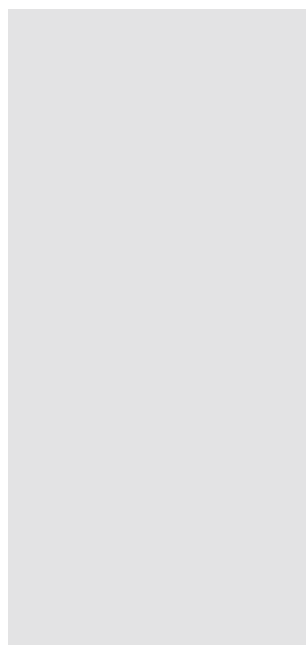

60x120 cm

>| 9 mm

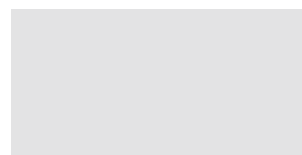

Price Codes

Formato (CM)	Full Lappato
120x260	A36
60x120	A10



Wall and floor: Silk Marble Grey

Nome	Spessore (MM)	Codice (Full Lappato)	Formato (CM)
silk marble grey	6	AGB62SLMBGRYZGSNLP	120x260
silk marble grey	9	AGB12SLMBGRYZHSS5P	60x120

Formato (cm)	Spessore (mm)	Pezzi X	M ² X	Kg X	X Eu. Pallet	M ² X Eu. Pallet	kg X Eu. Pallet
120x260	6	1	3.12	48.00	20	62.40	960.00
60x120	9	2	1.44	32.00	28	40.32	896.00

MAXIMUS
MEGA SLAB

Urban Marble



Wall: Urban Marble Ornate

Urban Marble



urban marble ornate

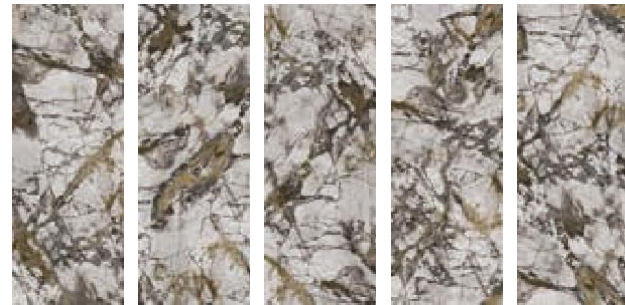

urban marble ornate variations
120x260

Formati | Sizes | Formats | Formatos

120x260 cm
>| 6 mm

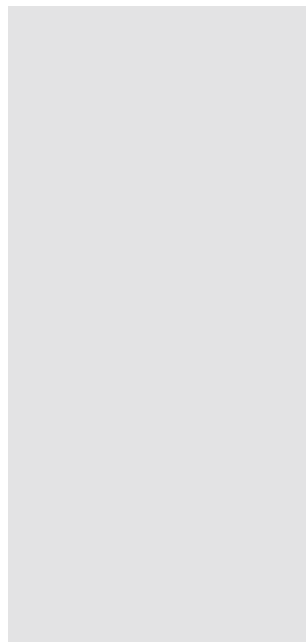

Price Codes

Formato(CM)	Full Lappato
120x260	A36



Nome	Spessore (MM)	Codice (Full Lappato)	Formato (CM)
urban marble ornate	6	A62GURBM-OLE.NoX6P	120x260

Formato (cm)	Spessore (mm)	Pezzi X	M² X	Kg X	X Eu. Pallet	M² X Eu. Pallet	kg X Eu. Pallet
120x260	6	1	3,12	48,00	20	62,40	960,00

MAXIMUS
MEGA SLAB

Versilia Marble



Wall: Versilia Marble White

Versilia Marble



versilia marble white



versilia marble white variations
120x260



versilia marble white variations
120x120

Formati | Sizes | Formats | Formatos

120x260 cm
>| 6 mm

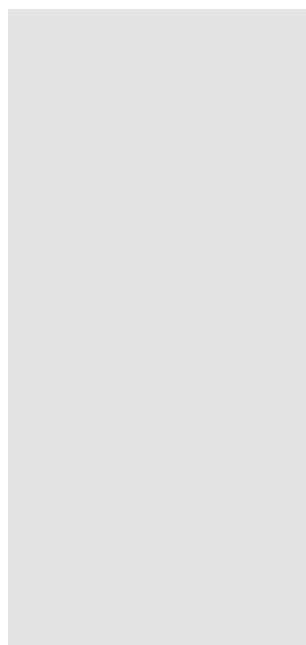

120x120 cm
>| 9 mm

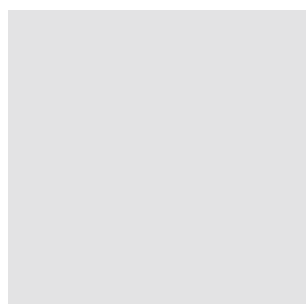

60x120 cm
>| 9 mm

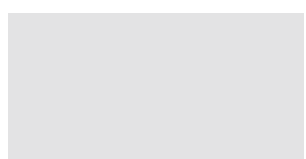

Finiture | Finishes | Finitions | Acabados

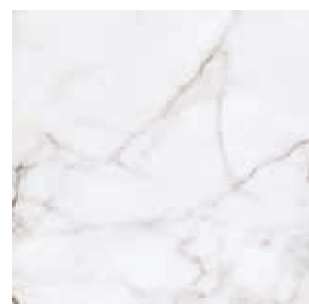

full lappato

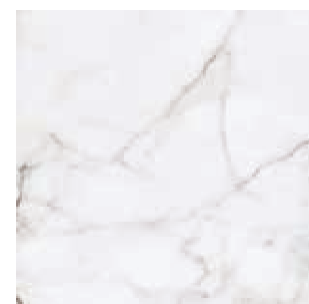

natural



Price Codes

Formato(CM)	Natural	Full Lappato
120x260	A36	A36
120x120	A21	A21
60x120	A10	A10



Floor: Versilia Marble White
Kitchen Top: Versilia Marble Hyper White

Nome	Spessore (MM)	Codice (Full Lappato)	Formato (CM)
versilia marble white	6	AGB62VSMBWHEZHSC6P	120x260
versilia marble white	9	AGB22VSMBWHEZHSC3P	120x120
versilia marble white	9	AGB12VSMBWHEZHSS5P	60x120

Nome	Spessore (MM)	Codice (Natural)	Formato (CM)
versilia marble white	6	A62GVSMB-WHE.MoX6R	120x260
versilia marble white	9	A22GVSMB-WHE.MoX5R	120x120
versilia marble white	9	A12GVSMB-WHE.MoX5R	60x120

Formato (cm)	Spessore (mm)	Pezzi X	M ² X	Kg X	X Eu. Pallet	M ² X Eu. Pallet	kg X Eu. Pallet
120x260	6	1	3.12	48.00	20	62.40	960.00
120x120	9	2	2.88	60.00	22	63.36	1320.00
60x120	9	2	1.44	32.00	28	40.32	896.00



Metallo

Tutti i riflessi di un materiale affascinante.
celebra gli spettacolari effetti ed i colori contrastanti creati durante il processo di invecchiamento del metallo grezzo. Con un aspetto audace e accattivante, le collezioni Metal sono perfette per ambienti urbani e industriali e si adattano a tutte le applicazioni interne ed esterne. Disponibili in una ampia gamma di colori e decori: acciaio, bronzo invecchiato, lamiere ossidate, etc. La gamma si abbina perfettamente a qualsiasi stile di interni, dando vita ad ambienti eleganti e sorprendenti.

Metal

All the variations of a fascinating material.

RAK Ceramics celebrates the dramatic effects and contrasting colours created during the ageing process of raw metal. With a bold and arresting appearance, the Metal collection for wall and floor, is perfect for urban and industrial settings. Metal-effect tiles are offered in a wide range of plain and decor: roughly ground steel, aged bronze, rusty metal sheet, etc. The range perfectly matches with any interior and decorative style, giving life to spaces that are both elegant and surprising.

Métal

Toutes les variations d'un matériel fascinant.

RAK Ceramics célèbre les effets spectaculaires et les couleurs contrastantes, créés pendant le processus de vieillissement du métal brut. Par leur aspect audace et captivant, les collections Metal sont parfaites pour les espaces urbains et industriels, et s'adaptent à toutes les applications internes et externes. Disponibles en une vaste gamme de couleurs et de décors: inox, bronze vieilli, tôle oxydée, etc. La gamme se combine parfaitement avec tout style d'intérieur, donnant la vie aux espaces élégants et surprenants.

Metal

Todas las variaciones de un material fascinante.

RAK Ceramics celebra los efectos dramáticos y los colores de contraste creados durante el proceso de envejecimiento del metal en bruto. Con una apariencia atrevida y llamativa, la colección Metal para paredes y pisos es perfecta para entornos urbanos e industriales. Las baldosas de efecto metal están disponibles en una amplia gama de opciones simples o con decoración: acero rectificado tosco, bronce envejecido, láminas de metal de acabado oxidado, etc. La gama combina perfectamente con cualquier tipo de interior y estilo decorativo, dando vida a los ambientes que resultan elegantes y sorprendentes.

Detroit Metal



Wall: Detroit Metal Brown 75x75 cm,
Floor: Detroit Metal Brown 75x75 cm

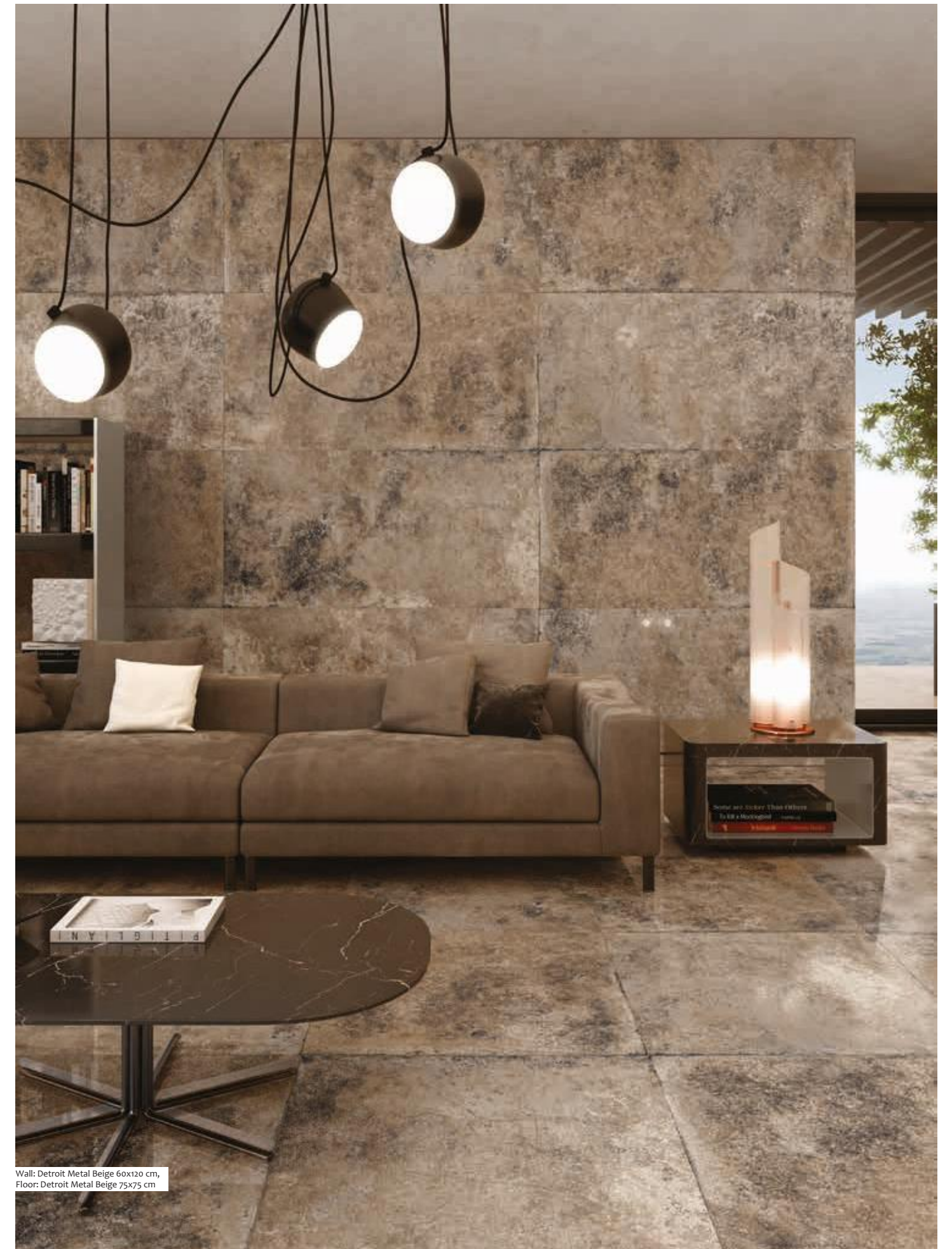

Wall: Detroit Metal Beige 60x120 cm,
Floor: Detroit Metal Beige 75x75 cm

Detroit Metal

METALLO



Wall: Detroit Metal Grey 75x75 cm

Detroit Metal



detroit metal beige



detroit metal brown



detroit metal taupe



detroit metal light grey



detroit metal grey

Formato (cm)	Spessore (mm)	Pezzi X	M ² X	Kg X	X Eu. Pallet	M ² X Eu. Pallet	kg X Eu. Pallet
75x75	9	2	1.12	25.00	45	50.40	1125.00
60x120	9	2	1.44	32.00	30	43.20	960.00
Battiscopa 7x75	9	10	0.525	13.00	54	28.35	702.00
Battiscopa 7x60	9	15	0.63	15.00	48	30.24	720.00

Formati | Sizes | Formats | Formatos

75x75 cm

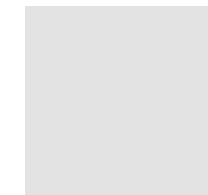

60x120 cm

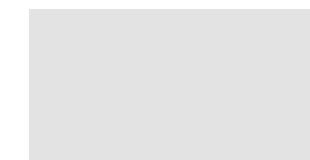

battiscopa
7x75 cm



battiscopa
7x60 cm



Price Codes

Formato(CM)	Lappato
75X75	A16
60X120	A18
Step 30x120	B55
Battiscopa 7x75	B3
Battiscopa 7X60	B2

Nome	Codice	Formato(CM)	Codice	Formato(CM)
detroit metal beige	AGB12DRMTBEEZMSS5L	60x120	AGB75DRMTBEEZMSS5L	75x75
detroit metal brown	AGB12DRMTBRNZMSS5L	60x120	AGB75DRMTBRNZMSS5L	75x75
detroit metal taupe	AGB12DRMTTPEZMSS5L	60x120	AGB75DRMTTPEZMSS5L	75x75
detroit metal light grey	AGB12DRMTLIGZMSS5L	60x120	AGB75DRMTLIGZMSS5L	75x75
detroit metal grey	AGB12DRMTGRYZMSS5L	60x120	AGB75DRMTGRYZMSS5L	75x75

Nome	Codice	Formato(CM)	Codice	Formato(CM)
detroit metal beige battiscopa	75DRM1L	7x75	60DRM1L	7x60
detroit metal brown battiscopa	75DRM2L	7x75	60DRM2L	7x60
detroit metal taupe battiscopa	75DRM5L	7x75	60DRM5L	7x60
detroit metal light grey battiscopa	75DRM4L	7x75	60DRM4L	7x60
detroit metal grey battiscopa	75DRM3L	7x75	60DRM3L	7x60

Evoque Metal

SIGNATURE
COLLECTION

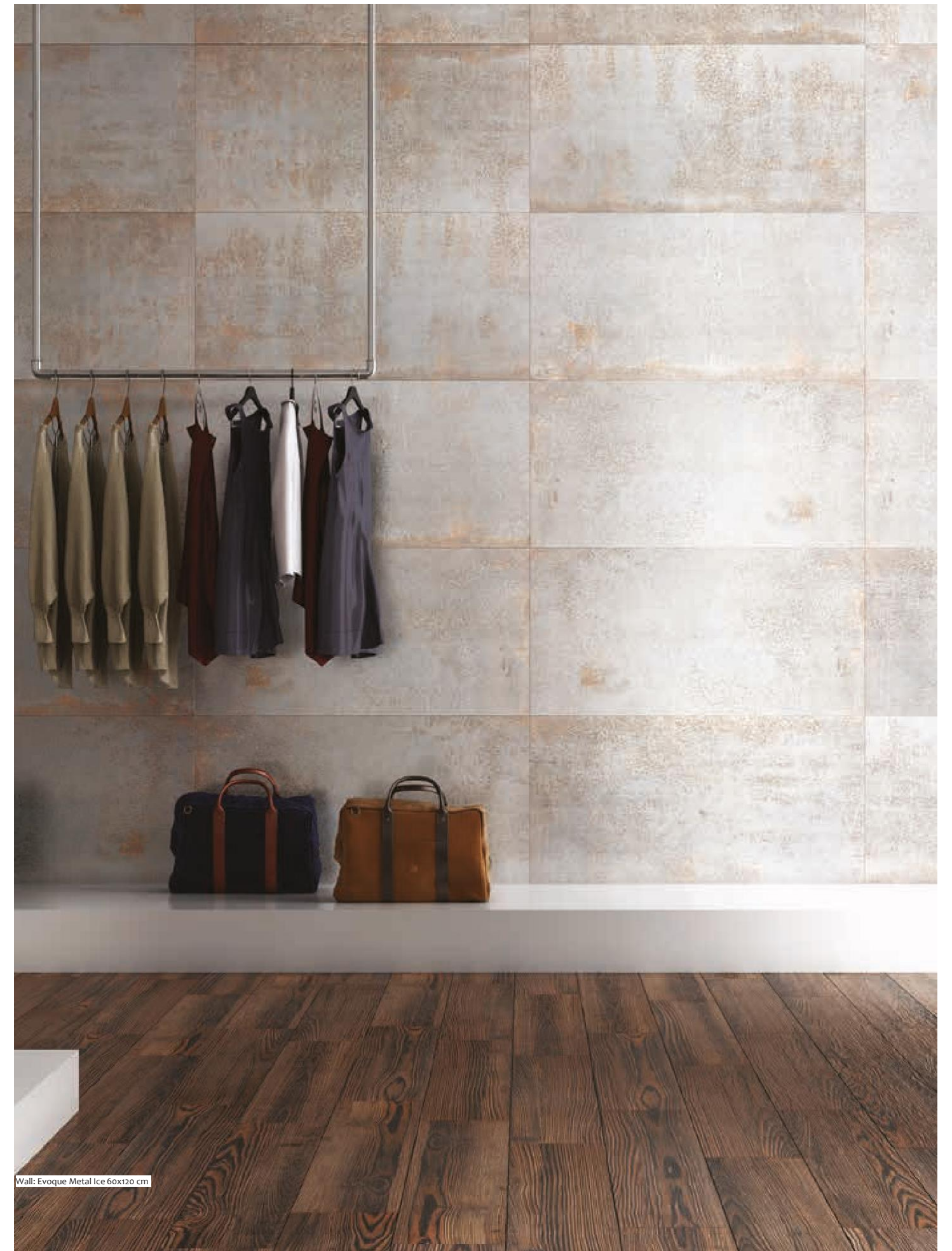

SIGNATURE
COLLECTION

Evoque Metal

Wall: Evoque Metal Ice Decor 60x120 cm
Floor: Evoque Metal Grey 60x60 cm

METALLO

Evoque Metal

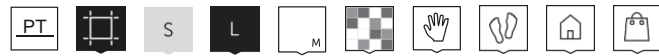

evoque metal ice



*evoque metal ice decor



evoque metal grey



*evoque metal grey decor



evoque metal green grey



*evoque metal green grey decor



evoque metal brown



*evoque metal brown decor

*Only available in: 60x120 cm

Formati | Sizes | Formats | Formatos

75x75 cm

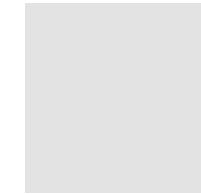

60x120 cm

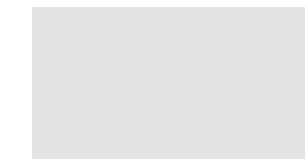

decor
60x120 cm

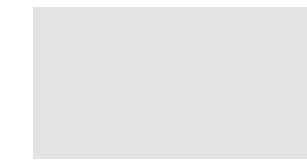

battiscopa
7x75 cm

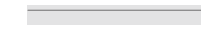

battiscopa
7x60 cm

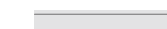

Price Codes

Formato(CM)	Lappato
75X75	A16
60X120	A18
Decor 60X120	A19
Step 30x120	B55
Battiscopa 7x75	B3
Battiscopa 7X60	B2

Nome	Codice	Formato(CM)	Nome	Codice	Formato(CM)
evoque metal ice	AGB75EVQMICEZMSS5L	75X75			
evoque metal grey	AGB75EVQMGRYZMSS5L	75X75			
evoque metal green grey	AGB75EVQMGNZMSS5L	75X75			
evoque metal brown	AGB75EVQMBRNZMSS5L	75X75			
evoque metal ice	AGB12EVQMICEZMSS5L	60x120	evoque metal ice decor	AGD12EVQMICEZMSSSL	60x120
evoque metal grey	AGB12EVQMGRYZMSS5L	60x120	evoque metal grey decor	AGD12EVQMGRYZMSSSL	60x120
evoque metal green grey	AGB12EVQMGNZMSS5L	60x120	evoque metal green grey decor	AGD12EVQMGNZMSSSL	60x120
evoque metal brown	AGB12EVQMBRNZMSS5L	60x120	evoque metal brown decor	AGD12EVQMBRNZMSSSL	60x120
evoque metal ice battiscopa	75EVQ4L	7x75	evoque metal ice battiscopa	60EVQ4L	7x60
evoque metal grey battiscopa	75EVQ3L	7x75	evoque metal grey battiscopa	60EVQ3L	7x60
evoque metal green grey battiscopa	75EVQ2L	7x75	evoque metal green grey battiscopa	60EVQ2L	7x60
evoque metal brown battiscopa	75EVQ1L	7x75	evoque metal brown battiscopa	60EVQ1L	7x60

Formato (cm)	Spessore (mm)	Pezzi X	M' X	Kg X	M' X Eu. Pallet	Kg X Eu. Pallet
75x75	9	2	1.12	23.00	43	960.00
60x120	9	2	1.44	32.00	30	960.00
Battiscopa 7x75	9	10	0.525	13.00	54	702.00

Icon Metal

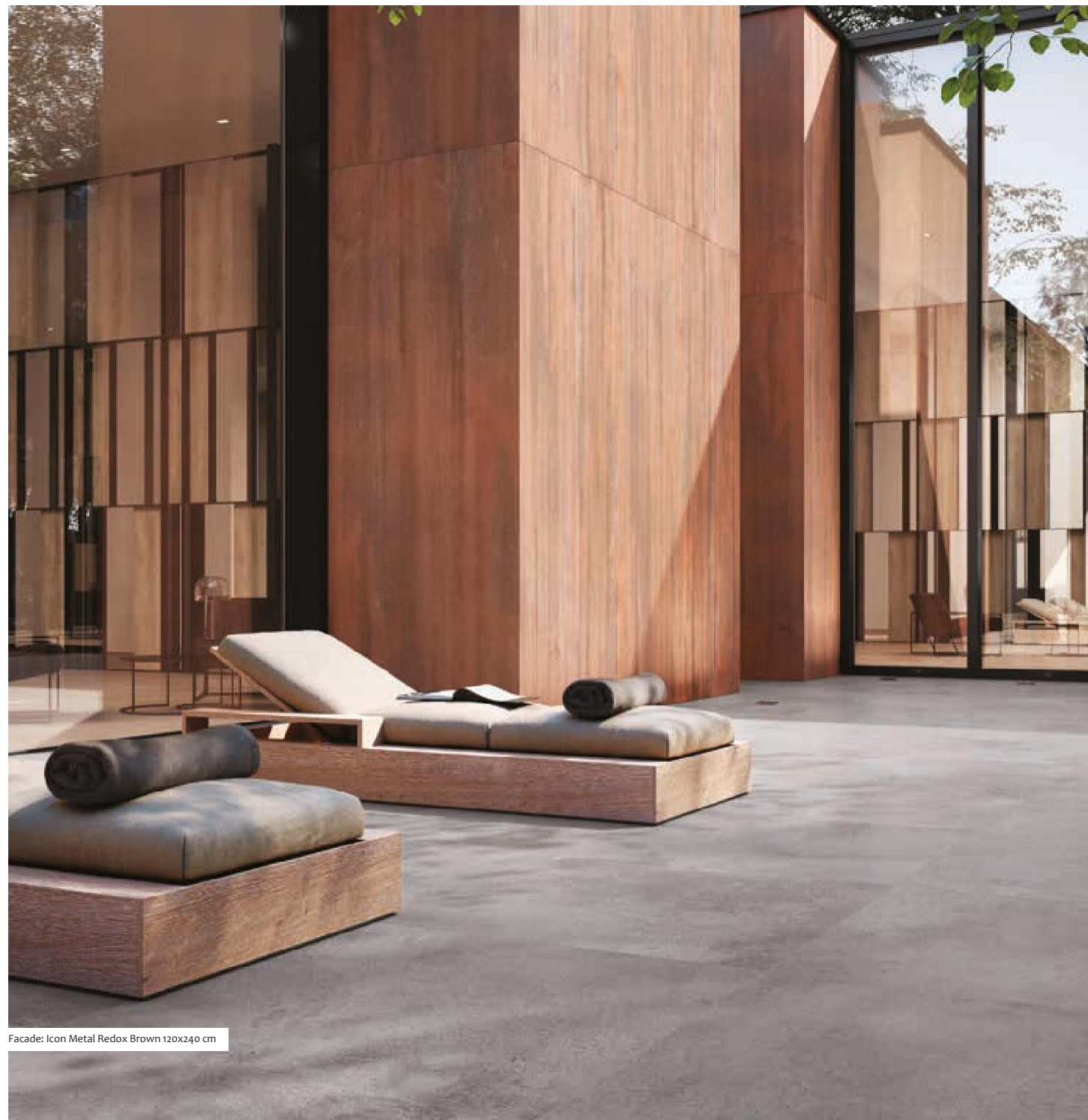

Facade: Icon Metal Redox Brown 120x240 cm



Counter and Furniture: Icon Metal Light Grey

Icon Metal

METALLO



Wall and Floor: Icon Metal Redox Brown 120x240 cm

Icon Metal



icon metal light grey

L



icon metal redox brown

N

Price Codes

Formato(CM)	Natural	Lappato
120x240	A35	A35
120x120	A21	A21

Formati | Sizes | Formats | Formatos

120x240 cm

>| 6 mm

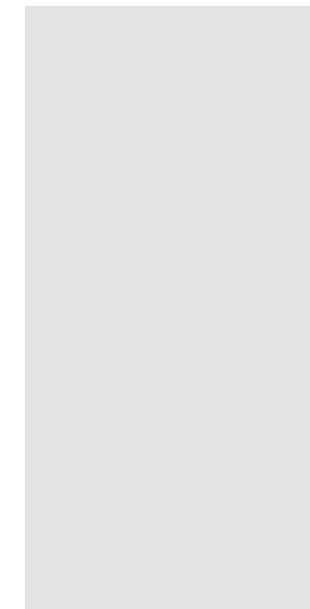

120x120 cm

>| 9 mm

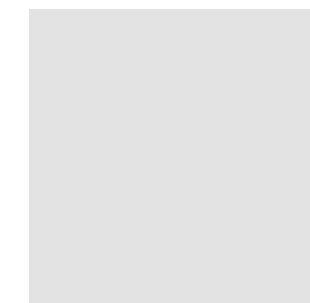

Finiture | Finishes | Finitions | Acabados

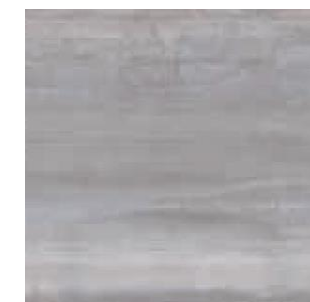

lappato

L

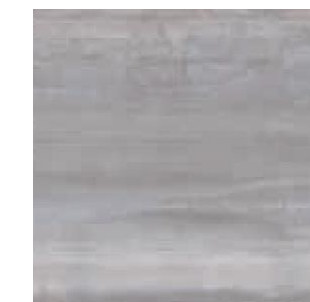

natural

N

Nome	Codice (Lappato)	Formato(CM)	Codice (Natural)	Formato(CM)
icon metal light grey	AGB46ICMTLIGZMSC6L	120x240	AG22ICMTLIGZMSC3R	120x120
icon metal redox brown	AGB46ICMTRXBZMSC6L	120x240	AGB22ICMTRXBZMSC3R	120x120

Formato (cm)	Spessore (mm)	Pezzi X	M ² X	Kg X	X Eu. Pallet	M ² X Eu. Pallet	kg X Eu. Pallet
120x240	6	1	2.88	43.50	24	69.12	1044.00
120x120	9	2	2.88	60.00	22	63.36	1320.00



Legno

Fatti ispirare dal legno.

Le piastrelle dall'aspetto naturale sono da sempre una delle principali tendenze per pavimenti interni ed esterni ed il legno è una delle scelte più apprezzate grazie alla sua versatilità e bellezza. La rivisitazione del legno in gres porcellanato di grande formato, crea un'opportunità nel progettare spazi con calore e intimità, nel modo più grandioso possibile. La collezione Maximus wood danno vita agli spazi; la scelta ideale per interni moderni e contemporanei.



Wood

Be inspired by wood effect tiles.

Natural-looking tiles are one of the key trends for indoor and outdoor surface coverings, and wood is one of the most popular choice thanks to its versatility and beauty. The reinterpretation of wood aesthetics in large format porcelain tile creates an opportunity in designing spaces with warmth and coziness, in the grandest way possible. Maximus wood collection brings life to spaces; ideal choice for modern and contemporary interiors



Bois

Faites-vous inspirer par le bois.

Les carreaux d'aspect naturel constituent de tout temps une des tendances principales pour les sols internes et externes, et le bois constitue un des choix les plus appréciés, grâce à sa versatilité et sa beauté. La réinterprétation du bois en grès porcelaine de grand format, crée une opportunité pour projeter des espaces dotés de chaleur et d'intimité, de manière la plus grandiose. Les collections Maximus wood donnent naissance aux espaces; le choix idéal pour les intérieurs modernes et contemporains.



Madera

Déjese inspirar por las baldosas de efecto madera.

Las baldosas de aspecto natural son una de las tendencias clave para pisos de interior y exterior, y la madera resulta ser una de las elecciones más populares debido a su versatilidad y belleza. La reinterpretación de la estética de la madera formato grande de baldosas de porcelana crea una oportunidad para diseñar espacios con calidez y comodidad, de la manera más grandiosa posible. La colección de maderas Maximus da vida a los espacios; elección ideal para interiores modernos y contemporáneos

Circle Wood



Floor: Circle Wood Grey 19,5x120 cm



Floor: Circle Wood Nut 19,5x120 cm

Circle Wood



Floor: Circle Wood Brown 19,5x120 cm

LEGNO

Circle Wood



circle wood ivory



circle wood grey



circle wood nut



circle wood beige



circle wood brown



circle wood greige

Formati | Sizes | Formats | Formatos

19.5x120 cm



Price Codes

Formato(CM)	Natural
19,5X120	A10

Nome	Codice	Formato(CM)
circle wood ivory	A99GZCRW#IVo.W2S5R	19,5x120
circle wood grey	A99GZCRW#GYo.W2S5R	19,5x120
circle wood nut	A99GZCRW#NUo.W2S5R	19,5x120
circle wood beige	A99GZCRW#BEo.W2S5R	19,5x120
circle wood brown	A99GZCRW#BRo.W2S5R	19,5x120
circle wood greige	A99GZCRW#GEo.W2S5R	19,5x120

Formato (cm)	Spessore (mm)	Pezzi X	M ² X	Kg X	X Eu. Pallet	M ² X Eu. Pallet	kg X Eu. Pallet
19,5x120	9	5	1,17	27,00	36	42,12	972,00

Line Wood

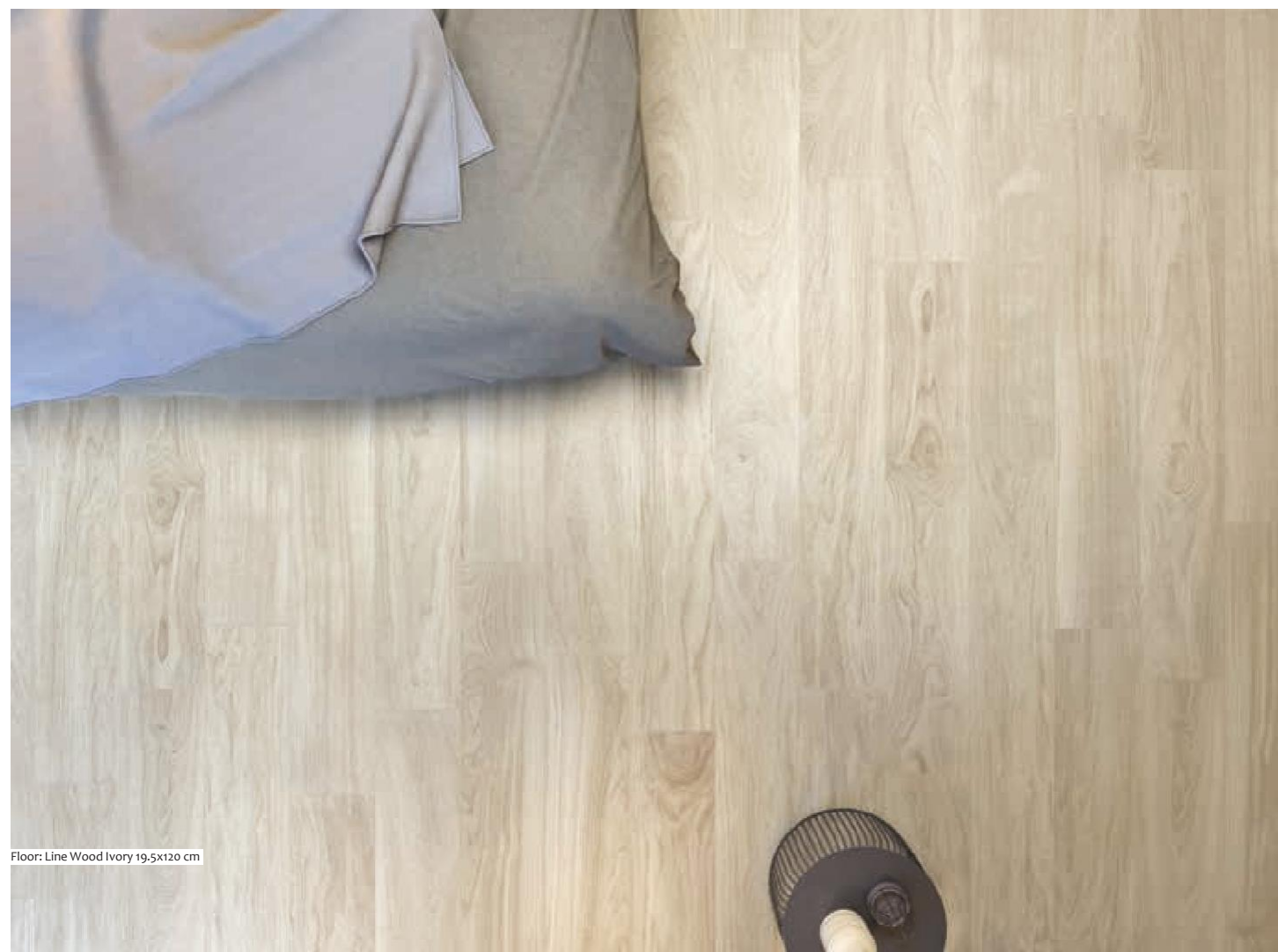

Floor: Line Wood Ivory 19,5x120 cm



Floor: Line Wood Nut 19,5x120 cm

Line Wood



Floor: Line Wood Dark Beige 19,5x120 cm R11

LEGNO

Line Wood

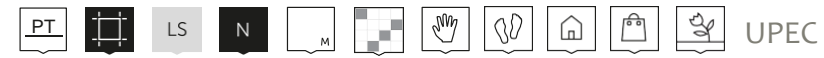

line wood ivory



line wood nut



line wood beige



line wood dark beige



line wood brown



line wood dark brown

Formati | Sizes | Formats | Formatos

19.5x120 cm

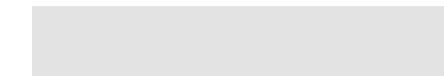

Outdoor
19.5x120 cm

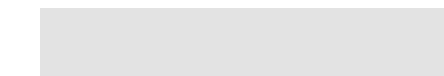

Price Codes

Formato(CM)	Natural	Outdoor
19.5X120	A10	A13

Nome	Codice	Formato(CM)	Codice	Formato(CM)
line wood ivory	AggGZLNW#IVo.W2S5R	19.5x120	AggGZLNW#IVo.WYS5R	19.5x120
line wood nut	AggGZLNW#NUo.W2S5R	19.5x120	AggGZLNW#NUo.WYS5R	19.5x120
line wood beige	AggGZLNW#BEo.W2S5R	19.5x120	AggGZLNW#BEo.WYS5R	19.5x120
line wood dark beige	AggGZLNW#DBE.W2S5R	19.5x120	AggGZLNW#DBE.WYS5R	19.5x120
line wood brown	AggGZLNW#BRo.W2S5R	19.5x120	AggGZLNW#BRo.WYS5R	19.5x120
line wood dark brown	AggGZLNW#DBR.W2S5R	19.5x120	AggGZLNW#DBR.WYS5R	19.5x120

Formato (cm)	Spessore (mm)	Pezzi X	M ² X	Kg X	Eu. Pallet	M ² X Eu. Pallet	kg X Eu. Pallet
19.5x120	9	5	1.17	27.00	36	42.12	972.00

Select Wood





Floor: Select Wood Ice 19,5x120 cm

Select Wood



select wood ice



select wood bone



select wood nut



select wood oak



select wood brown



select wood dark brown



Formati | Sizes | Formats | Formatos

19.5x120 cm

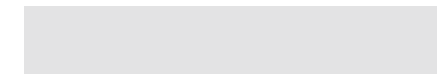

Price Codes

Formato(CM)	Natural
19,5X120	A10

Nome	Codice	Formato(CM)
select wood ice	AGX2HSEWDICEZMH55R	19,5x120
select wood bone	AGX2HSEWDBNEZMH55R	19,5x120
select wood nut	AGX2HSEWDNUTZMH55R	19,5x120
select wood oak	AGX2HSEWDOAKZMH55R	19,5x120
select wood brown	AGX2HSEWDBRNZMH55R	19,5x120
select wood dark brown	AGX2HSEWDBRNZMH55R	19,5x120

Formato (cm)	Spessore (mm)	Pezzi X	M ² X	Kg X	X Eu. Pallet	M ² X Eu. Pallet	kg X Eu. Pallet
19,5x120	9	5	1,17	27,00	36	42,12	972,00



Cemento

La piu' avanzata espressione del minimalismo.

Le collezioni Cemento Maximus si fanno notare grazie alla loro semplicità. Solo pura perfezione. Una ideale rappresentazione dello stile contemporaneo, ideale per creare un look minimalista attraverso lastre giganti effetto cemento. Applicate su elementi di arredo e rivestimenti interni ed esterni, le soluzioni Maximus sono straordinariamente audaci e di grande impatto estetico, forti e semplici come il calcestruzzo industriale.



Concrete

The ultimate expression of minimalism.

Maximus' concrete collections make a powerful statement with their sheer simplicity. No fuss, no frills, just pure perfection. Packed full of contemporary style, the concrete effect big slabs are the ideal choice for creating a minimalist look and feel. Applied on furniture or indoor and outdoor cladding, the Maximus solutions are strikingly bold and beautiful, inspired by the simplicity and strength of industrial concrete.



Béton

L'expression la plus avancée du minimalisme.

Les collections Ciment RAK Ceramics attirent l'attention grâce à leur simplicité. Rien que la pure perfection. Avec leurs couleurs neutres et leurs textures naturelles, elles constituent la solution idéale pour créer un look minimaliste et contemporain. Versatiles et extraordinairement audaces, elles se combinent parfaitement avec tout type d'ameublement, contemporain ou minimaliste, dans des contextes résidentiels ou industriels.



Concreto

La máxima expresión del minimalismo.

La colección de concreto de RAK Ceramics hace una declaración poderosa con su simple simplicidad. Sin alboroto ni adornos, simplemente pura perfección. Con su color neutro y su textura natural, las baldosas de aspecto concreto son la elección ideal para crear un aspecto y sensación minimalista. Es una colección versátil que se adapta bien a cualquier entorno, ya sea con un estilo contemporáneo o minimalista, o bien en contextos residenciales o en el sector contract.

Basic Concrete



Wall: Basic Concrete Grey Multi Strip Mosaic 15x60 cm
Floor: Basic Concrete Black 60x60 cm



Wall: Basic Concrete Brown Multi Strip Mosaic 15x60 cm
Floor: Basic Concrete Dark Beige 60x60 cm

Basic Concrete



Wall: Basic Concrete Black Mosaic 30x30 cm
Floor: Basic Concrete Dark Grey 60x60 cm

CEMENTO

Basic Concrete



basic concrete grey



basic concrete dark grey



basic concrete black



basic concrete beige



RAK-Sanit
HEALTHCARE SOLUTIONS

With the new RAK-Sanit program, RAK Ceramics offers a wide range of solutions for floors, walls and sanitaryware, made with glazes that inhibit the growth of bacteria, thus reducing the possibility of contagion and contributing to create a healthier environment.

RAK-Sanit is the ideal solution for modern and safer schools, public and private offices, restaurants, hotels, laboratories and for all the spaces where hygiene is of primary importance.

Available on request for grey, beige and dark grey in 60x60 cm

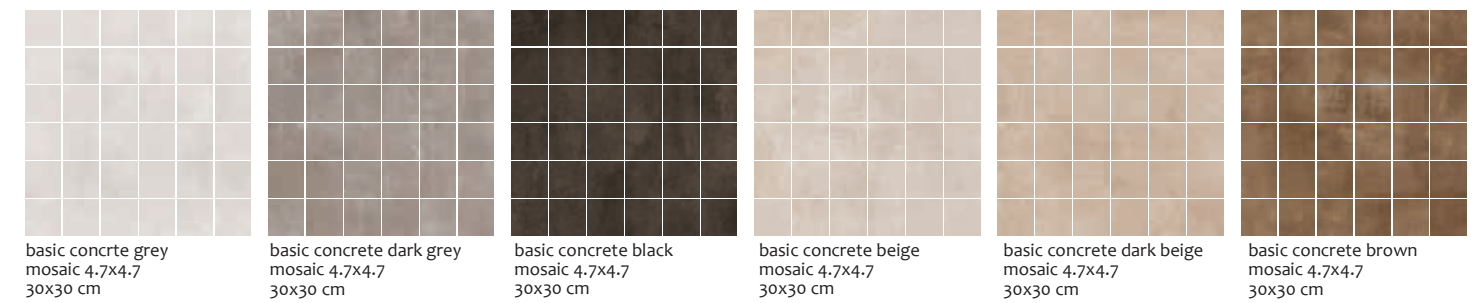

Formati | Sizes | Formats | Formatos

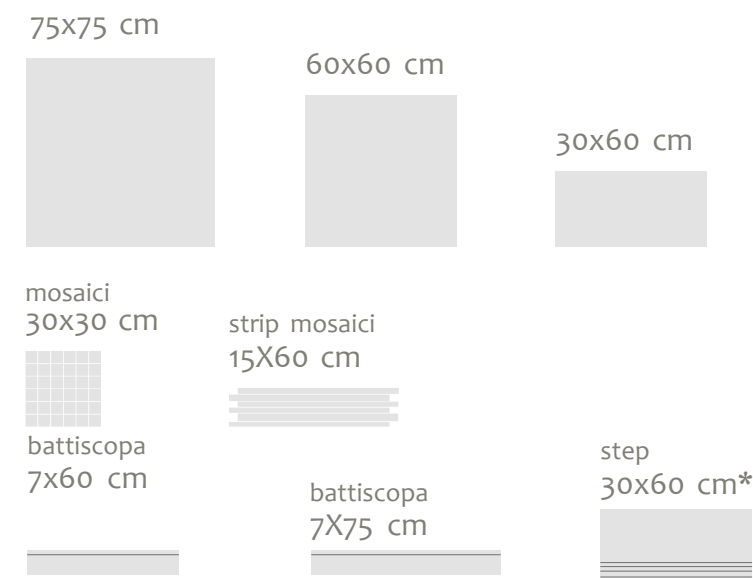







Price Codes

Formato(CM)	Natural
75X75	A9
60X60	A6
30X60	A2
Step 30x60	B7
Battiscopa 7x75	B2
Battiscopa 7X60	B1
Mosaici 30x30	B9
Mosaici 15x60	

Basic Concrete

Nome	Codice	Formato(CM)	Codice	Formato(CM)	Codice	Formato(CM)
basic concrete grey	A75GZBSC-GYo.M2S5R	75x75	Ao6GZBSC-GYo.M2R	60x60	Ao9GZBSC#GYo.M2R	30x60
basic concrete dark grey	A75GZBSC-DGY.M2S5R	75x75	Ao6GZBSC-DGY.M2R	60x60	Ao9GZBSC#DGY.M2R	30x60
basic concrete beige	A75GZBSC-BEo.M2S5R	75x75	Ao6GZBSC-BEo.M2R	60x60	Ao9GZBSC#BEo.M2R	30x60
basic concrete dark beige	A75GZBSC-DBE.M2S5R	75x75	Ao6GZBSC-DBE.M2R	60x60	Ao9GZBSC#DBE.M2R	30x60
basic concrete black	A75GZBSC-BKo.M2R	75x75	Ao6GZBSC-BKo.M2R	60x60	Ao9GZBSC#BKo.M2R	30x60
basic concrete brown	A75GZBSC-BRo.M2R	75x75	Ao6GZBSC-BRo.M2R	60x60	Ao9GZBSC#BRo.M2R	30x60
Nome	Codice	Formato(CM)	Codice	Formato(CM)	Codice	Formato(CM)
basic concrete grey mosaic 4.7x4.7	AM-GZBSC-GY.2R/5H	30x30	basic concrete grey multi strip mosaic	AMBGZBSC-GY.2R/BRK	15x60	
basic concrete dark grey mosaic 4.7x4.7	AM-GZBSC-DGY.2R/5H	30x30	basic concrete dark grey multi strip mosaic	AMBGZBSC-DG.2R/BRK	15x60	
basic concrete beige mosaic 4.7x4.7	AM-GZBSC-BE.2R/5H	30x30	basic concrete beige multi strip mosaic	AMBGZBSC-BE.2R/BRK	15x60	
basic concrete dark beige mosaic 4.7x4.7	AM-GZBSC-DBE.2R/5H	30x30	basic concrete dark beige multi strip mosaic	AMBGZBSC-DB.2R/BRK	15x60	
basic concrete black mosaic 4.7x4.7	AM-GZBSC-BK.2R/5H	30x30	basic concrete black multi strip mosaic	AMBGZBSC-BK.2R/BRK	15x60	
basic concrete brown mosaic 4.7x4.7	AM-GZBSC-BR.2R/5H	30x30	basic concrete brown multi strip mosaic	AMBGZBSC-BR.2R/BRK	15x60	
Nome	Codice	Formato(CM)	Codice	Formato(CM)	Codice	Formato(CM)
basic concrete grey battiscopa 7x60	60BSC6N	7x60	basic concrete grey battiscopa 7x75	75BSC6N	7x75	
basic concrete dark grey battiscopa 7x60	60BSC5N	7x60	basic concrete dark grey battiscopa 7x75	75BSC5N	7x75	
basic concrete beige battiscopa 7x60	60BSC1N	7x60	basic concrete beige battiscopa 7x75	75BSC1N	7x75	
basic concrete dark beige battiscopa 7x60	60BSC4N	7x60	basic concrete dark beige battiscopa 7x75	75BSC4N	7x75	
basic concrete black battiscopa 7x60	60BSC2N	7x60	basic concrete black battiscopa 7x75	75BSC2N	7x75	
basic concrete brown battiscopa 7x60	60BSC3N	7x60	basic concrete brown battiscopa 7x75	75BSC3N	7x75	
Nome	Codice	Formato(CM)				
basic concrete grey step	*su richiesta	30x60				
basic concrete dark grey step	*su richiesta	30x60				
basic concrete beige step	*su richiesta	30x60				
basic concrete dark beige step	*su richiesta	30x60				
basic concrete black step	*su richiesta	30x60				
basic concrete brown step	*su richiesta	30x60				

Formato (cm)	Spessore (mm)	Pezzi X 	M² X 	Kg X 	 X  Eu. Pallet	M² X  Eu. Pallet	kg X  Eu. Pallet
75x75	9	2	1.12	25.00	45	50.40	1125.00
60x60	9	4	1.44	32.00	30	43.20	960.00
30x60	9	6	1.08	24.50	48	51.84	1176.00
Mosaici 30x30	9	10	-	14.00	48	-	672.00
Strip mosaici 15x60	9	6	-	10.00	42	-	420.00
Steps 30x60	8	8	1.44	20.52	40	57.60	820.80



Wall: Basic Concrete Black Mosaic 30x30 cm

Cementina



Floor: Cementina Brown 60x60 cm

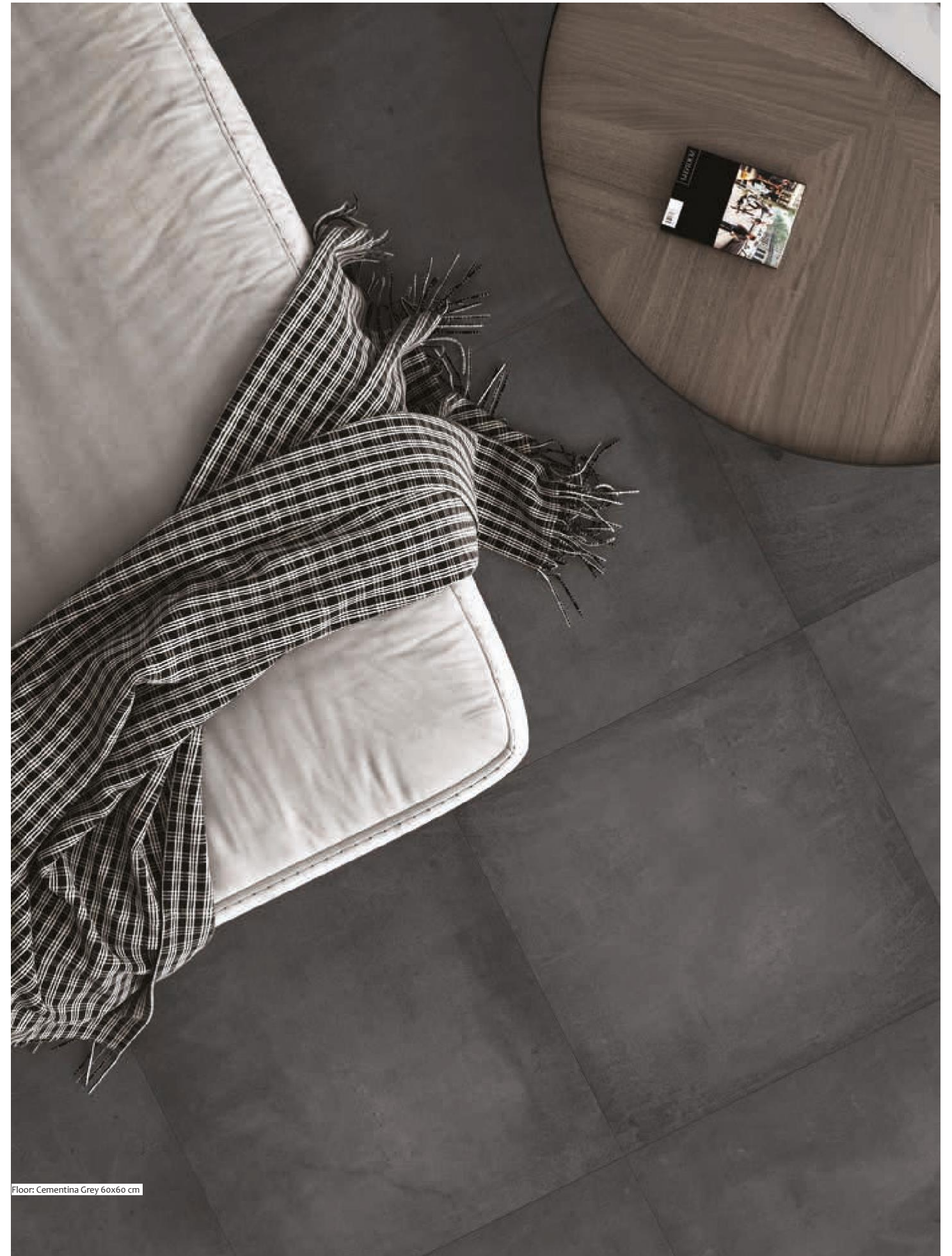

Floor: Cementina Grey 60x60 cm



Cementina

Floor: Cementina Grey 60x60 cm

CEMENTO

Cementina



cementina grey



cementina beige



cementina anthracite

Formati | Sizes | Formats | Formatos

60x60 cm

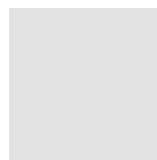

battiscopa
7x60 cm

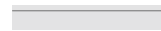

Price Codes

Formato(CM)	Natural
60x60	A6
Battiscopa 7x60	B1



Floor: Cementina Grey 75x75 cm

Nome	Codice	Formato(CM)	Codice	Formato(CM)	Codice	Formato(CM)
cementina grey battiscopa	60CEM1N	7x60	A06GZCEM-GYo.M2R	60x60	A09GZCEM-GYo.M2R	30x60
cementina anthracite battiscopa	60CEM2N	7x60	A06GZCEM-ANT.M2R	60x60	A09GZCEM-ANO.M2R	30x60
cementina beige battiscopa	60CEM3N	7x60	A06GZCEM-BEo.M2R	60x60	A09GZCEM-BEo.M2R	30x60

Formato (cm)	Spessore (mm)	Pezzi X	M ² X	Kg X	X Eu. Pallet	M ² X Eu. Pallet	kg X Eu. Pallet
60x60	9	4	1.44	32.00	30	43.20	960.00
Battiscopa 7x60	9	15	0.63	15.00	48	30.24	720.00

Surface 2.0

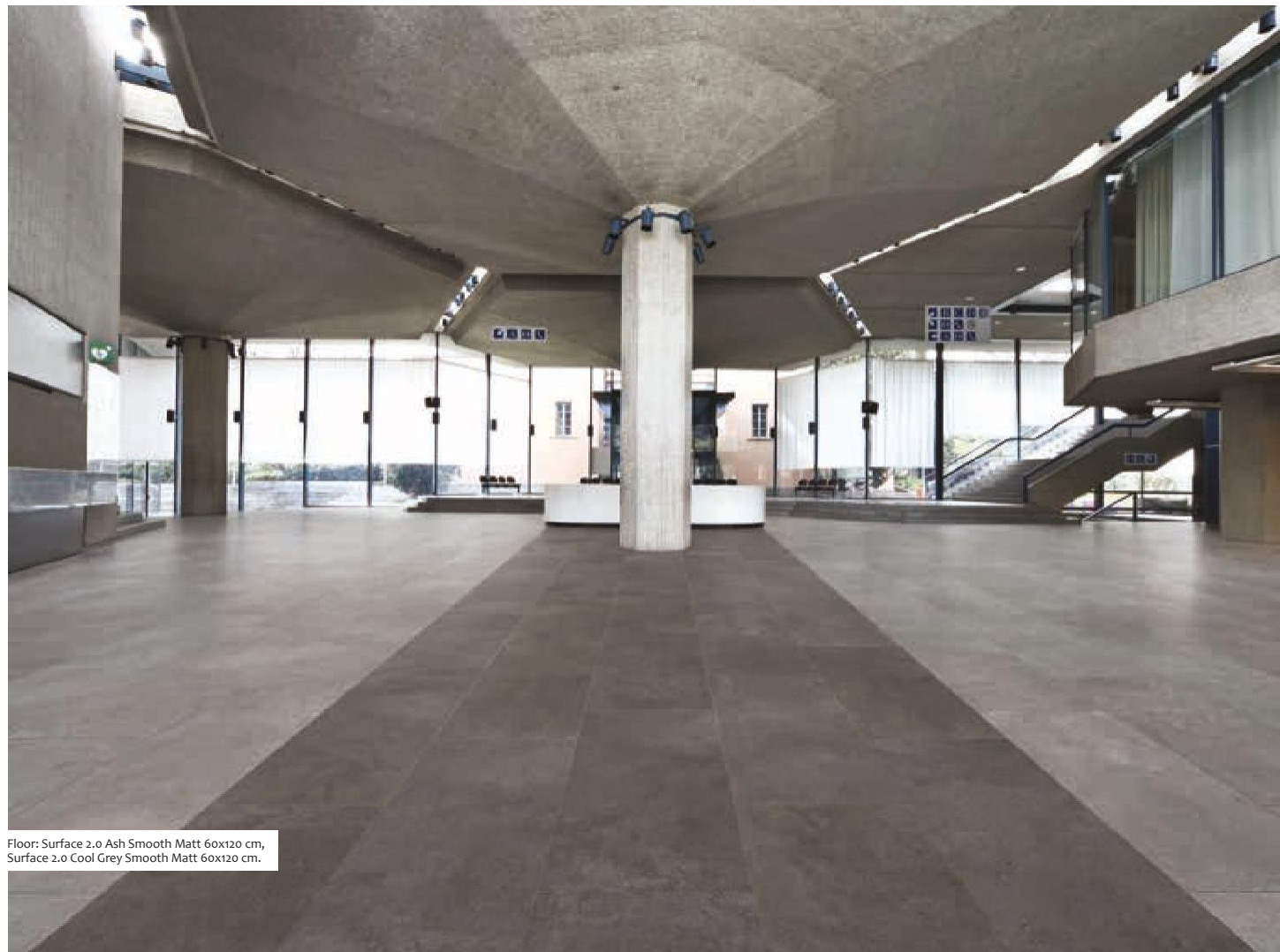

Floor: Surface 2.0 Ash Smooth Matt 60x120 cm,
Surface 2.0 Cool Grey Smooth Matt 60x120 cm.



Wall and Floor: Surface 2.0 Sand Smooth Matt 60x60 cm

Surface 2.0



Floor: Surface 2.0 Mid Grey Smooth Matt 60x60 cm

CEMENTO

Surface 2.0

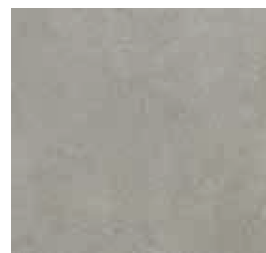
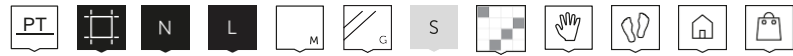

*surface 2.0 cool grey



surface 2.0 mid grey



surface 2.0 ash

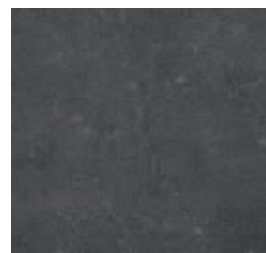

surface 2.0 night



*surface 2.0 off white

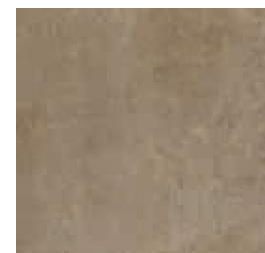

surface 2.0 clay

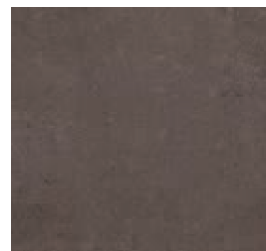

surface 2.0 charcoal



*surface 2.0 sand



surface 2.0 light sand



surface 2.0 greige

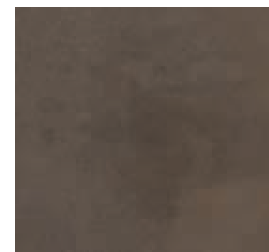

surface 2.0 dark greige



surface 2.0 copper

RAK-Sanit
HEALTHCARE SOLUTIONS

With the new RAK-Sanit program, RAK Ceramics offers a wide range of solutions for floors, walls and sanitaryware, made with glazes that inhibit the growth of bacteria, thus reducing the possibility of contagion and contributing to create a healthier environment.

RAK-Sanit is the ideal solution for modern and safer schools, public and private offices, restaurants, hotels, laboratories and for all the spaces where hygiene is of primary importance.

Available on request for cool grey, sand and off white in 60x60 cm

*Available in: 120x260 cm and 120x120 cm only in natural finish

Formati | Sizes | Formats | Formatos

*120x260 cm

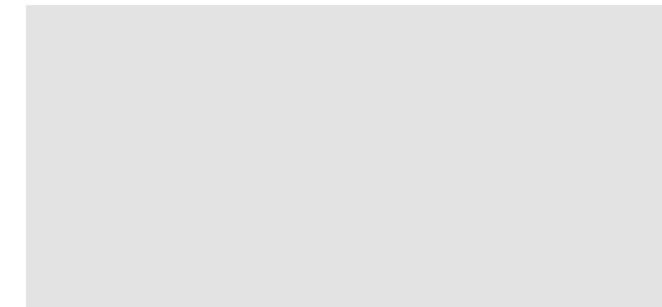

*120x120 cm

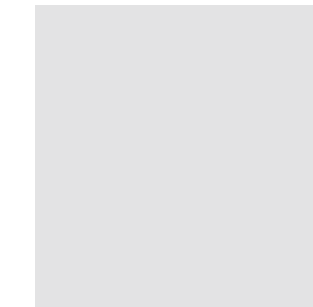

75x75 cm

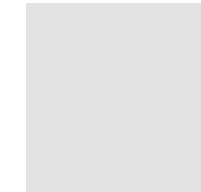

60x120 cm

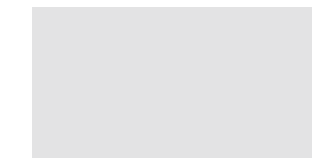

60x60 cm

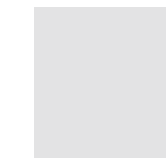

30x60 cm



mosaici 2.5x2.5
30x30 cm



mosaici 3x6
30x30 cm



brick mosaici
30x30 cm

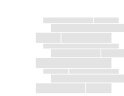

step
30x60 cm



battiscopa
7x60 cm



Finiture | Finishes | Finitions | Acabados



lappato

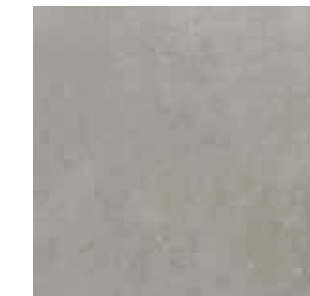

natural



Price Codes

Formato(CM)	Natural	Lappato	Outdoor
120x260	A32	-	-
120x120	A17	-	-
75x75	A9	A12	-
60x120	A12	A14	-
60x60	A6	A11	A20
30x60	A2	A4	-

Formato(CM)	Natural	Lappato	Outdoor
Step 30x120	B50	-	-
Step 30x60	B7	-	-
Battiscopa 7x75	B2	B3	-
Battiscopa 7x60	B1	B2	-
Mosaici 30x30	B9	B10	-

Formato (cm)	Spessore (mm)	Pezzi X	M' X	Kg X	X Eu. Pallet	M' X Eu. Pallet	kg X Eu. Pallet
75x75	9	2	1.12	25.00	45	50.40	1125.00
60x120	9	15	1.44	32.00	30	43.20	960.00
60x60	9	4	1.44	32.00	30	43.20	960.00
30x60	9	6	1.08	24.50	48	51.84	1176.00
Mosaici 30x30	9	10	-	14.00	48	-	672.00
Steps 30x60	8	8	1.44	20.52	40	57.60	820.80
Battiscopa 7x60	9	15	0.63	15.00	48	30.24	720.00

Surface 2.0

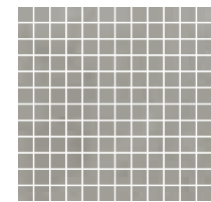

surface 2.0 cool grey mosaic 2.5x2.5 30x30 cm

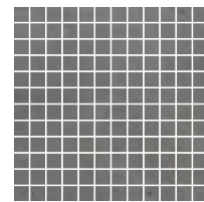

surface 2.0 mid grey mosaic 2.5x2.5 30x30 cm

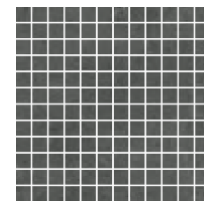

surface 2.0 ash mosaic 2.5x2.5 30x30 cm

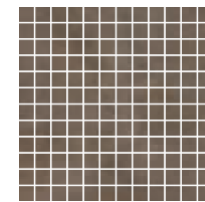

surface 2.0 greige mosaic 2.5x2.5 30x30 cm

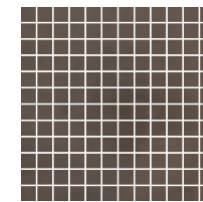

surface 2.0 dark greige mosaic 2.5x2.5 30x30 cm

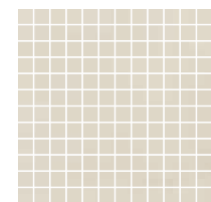

surface 2.0 off white mosaic 2.5x2.5 30x30 cm

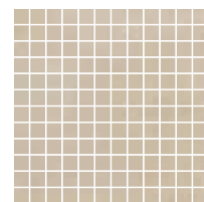

surface 2.0 sand mosaic 2.5x2.5 30x30 cm

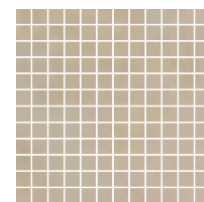

surface 2.0 light sand mosaic 2.5x2.5 30x30 cm

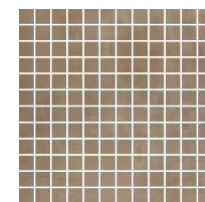

surface 2.0 clay mosaic 2.5x2.5 30x30 cm

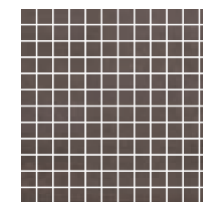

surface 2.0 charcoal mosaic 2.5x2.5 30x30 cm

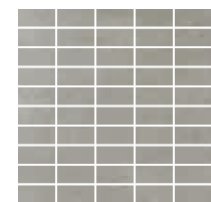

surface 2.0 cool grey mosaic 3x6 30x30 cm

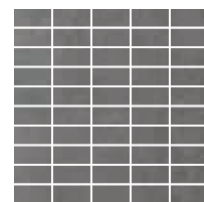

surface 2.0 mid grey mosaic 3x6 30x30 cm

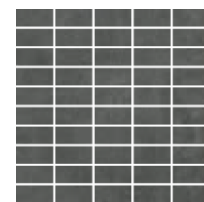

surface 2.0 ash mosaic 3x6 30x30 cm

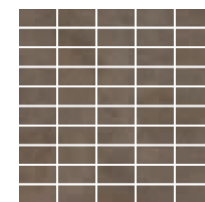

surface 2.0 greige mosaic 3x6 30x30 cm

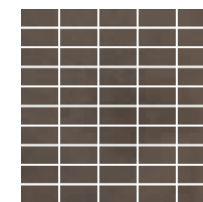

surface 2.0 dark greige mosaic 3x6 30x30 cm

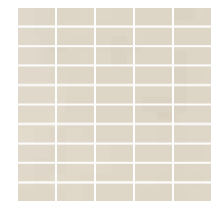

surface 2.0 off white mosaic 3x6 30x30 cm

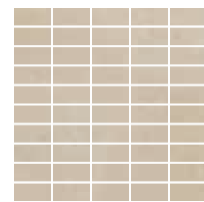

surface 2.0 sand mosaic 3x6 30x30 cm

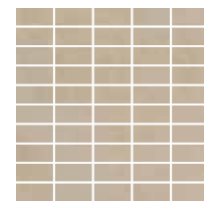

surface 2.0 light sand mosaic 3x6 30x30 cm

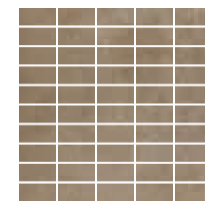

surface 2.0 clay mosaic 3x6 30x30 cm

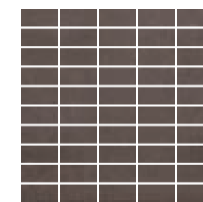

surface 2.0 charcoal mosaic 3x6 30x30 cm



surface 2.0 cool grey brick mosaic 30x30 cm



surface 2.0 mid grey brick mosaic 30x30 cm

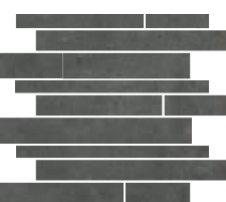

surface 2.0 ash brick mosaic 30x30 cm



surface 2.0 greige brick mosaic 30x30 cm



surface 2.0 dark greige brick mosaic 30x30 cm



surface 2.0 off white brick mosaic 30x30 cm



surface 2.0 light sand brick mosaic 30x30 cm



surface 2.0 sand brick mosaic 30x30 cm

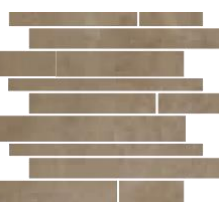

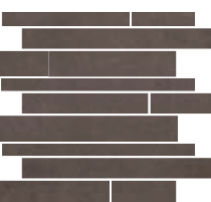

surface 2.0 clay brick mosaic 30x30 cm





surface 2.0 charcoal brick mosaic 30x30 cm



Nome	Codice Natural	Formato(CM)	Codice Lappato	Formato(CM)
surface 2.0 off white	AGB62ZSFOWZMSNLR	120x260		
surface 2.0 cool grey	AGB62ZSFXCGYZMSC6R	120x260		
surface 2.0 sand	AGB62ZSFXWHTZMSNLR	120x260		
surface 2.0 off white	Al22GSFX-OWH.MoC3R	120x120		
surface 2.0 cool grey	Al22GSFX-CGY.MoC3R	120x120		
surface 2.0 sand	Al22GSFX-SN.MoC3R	120x120		
surface 2.0 off white	A75GZSUR-OWH.MoS5R	75x75	A75GZSUR-OWH.MoS5L	75x75
surface 2.0 cool grey	A75GZSUR-CGY.MoS5R	75x75	A75GZSUR-CGY.MoS5L	75x75
surface 2.0 mid grey	A75GZSUR-MGY.MoS5R	75x75	A75GZSUR-MGY.MoS5L	75x75
surface 2.0 ash	A75GZSUR-ASo.MoS5R	75x75	A75GZSUR-ASo.MoS5L	75x75
surface 2.0 night	A75GZSUR-NTo.MoS5R	75x75	A75GZSUR-NTo.MoS5L	75x75
surface 2.0 greige	A75GZSUR-GEo.MoS5R	75x75	A75GZSUR-GEo.MoS5L	75x75
surface 2.0 dark greige	A75GZSUR-DGE.MoS5R	75x75	A75GZSUR-DGE.MoS5L	75x75
surface 2.0 light sand	A75GZSUR-LSN.MoS5R	75x75	A75GZSUR-LSN.MoS5L	75x75
surface 2.0 sand	A75GZSUR-SNo.MoS5R	75x75	A75GZSUR-SNo.MoS5L	75x75
surface 2.0 clay	A75GZSUR-CLo.MoS5R	75x75	A75GZSUR-CLo.MoS5L	75x75
surface 2.0 charcoal	A75GZSUR-CBK.MoS5R	75x75	A75GZSUR-CBK.MoS5L	75x75
surface 2.0 copper	A75GZSUR-CPo.MoS5R	75x75	A75GZSUR-CPo.MoS5L	75x75
surface 2.0 off white	A12GZSUR-OWH.MoS5R	60x120	A12GZSUR-OWH.MoS5L	60x120
surface 2.0 cool grey	A12GZSUR-CGY.MoS5R	60x120	A12GZSUR-CGY.MoS5L	60x120
surface 2.0 mid grey	A12GZSUR-MGY.MoS5R	60x120	A12GZSUR-MGY.MoS5L	60x120
surface 2.0 ash	A12GZSUR-ASo.MoS5R	60x120	A12GZSUR-ASo.MoS5L	60x120
surface 2.0 night	A12GZSUR-NTo.MoS5R	60x120	A12GZSUR-NTo.MoS5L	60x120
surface 2.0 greige	A12GZSUR-GEo.MoS5R	60x120	A12GZSUR-GEo.MoS5L	60x120
surface 2.0 dark greige	A12GZSUR-DGE.MoS5R	60x120	A12GZSUR-DGE.MoS5L	60x120
surface 2.0 light sand	A12GZSUR-LSN.MoS5R	60x120	A12GZSUR-LSN.MoS5L	60x120
surface 2.0 sand	A12GZSUR-SNo.MoS5R	60x120	A12GZSUR-SNo.MoS5L	60x120
surface 2.0 clay	A12GZSUR-CLo.MoS5R	60x120	A12GZSUR-CLo.MoS5L	60x120
surface 2.0 charcoal	A12GZSUR-CBK.MoS5R	60x120	A12GZSUR-CBK.MoS5L	60x120
surface 2.0 copper	A12GZSUR-CPo.MoS5R	60x120	A12GZSUR-CPo.MoS5L	60x120
surface 2.0 off white	A06GZSUR-OWH.MoR	60x60	A06GZSUR-OWH.MoL	60x60
surface 2.0 cool grey	A06GZSUR-CGY.MoR	60x60	A06GZSUR-CGY.MoL	60x60
surface 2.0 mid grey	A06GZSUR-MGY.MoR	60x60	A06GZSUR-MGY.MoL	60x60
surface 2.0 ash	A06GZSUR-ASo.MoR	60x60	A06GZSUR-ASo.MoL	60x60
surface 2.0 night	A06GZSUR-NTo.MoR	60x60	A06GZSUR-NTo.MoL	60x60
surface 2.0 greige	A06GZSUR-GEo.MoR	60x60	A06GZSUR-GEo.MoL	60x60
surface 2.0 dark greige	A06GZSUR-DGE.MoR	60x60	A06GZSUR-DGE.MoL	60x60
surface 2.0 light sand	A06GZSUR-LSN.MoR	60x60	A06GZSUR-LSN.MoL	60x60
surface 2.0 sand	A06GZSUR-SNo.MoR	60x60	A06GZSUR-SNo.MoL	60x60
surface 2.0 clay	A06GZSUR-CLo.MoR	60x60	A06GZSUR-CLo.MoL	60x60
surface 2.0 charcoal	A06GZSUR-CBK.MoR	60x60	A06GZSUR-CBK.MoL	60x60
surface 2.0 copper	A06GZSUR-CPo.MoR	60x60	A06GZSUR-CPo.MoL	60x60
surface 2.0 off white	A09GZSUR-ASo.MoR	30x60	A09GZSUR-ASo.MoL	30x60
surface 2.0 cool grey	A09GZSUR-CGY.MoR	30x60	A09GZSUR-CGY.MoL	30x60
surface 2.0 mid grey	A09GZSUR-MGY.MoR	30x60	A09GZSUR-MGY.MoL	30x60
surface 2.0 ash	A09GZSUR-ASo.MoR	30x60	A09GZSUR-ASo.MoL	30x60
surface 2.0 night	A09GZSUR-NTo.MoR	30x60	A09GZSUR-NTo.MoL	30x60
surface 2.0 greige	A09GZSUR-GEo.MoR	30x60	A09GZSUR-GEo.MoL	30x60
surface 2.0 dark greige	A09GZSUR-DGE.MoR	30x60	A09GZSUR-DGE.MoL	30x60
surface 2.0 light sand	A09GZSUR-LSN.MoR	30x60	A09GZSUR-LSN.MoL	30x60
surface 2.0 sand	A09GZSUR-SNo.MoR	30x60	A09GZSUR-SNo.MoL	30x60
surface 2.0 clay	A09GZSUR-CLo.MoR	30x60	A09GZSUR-CLo.MoL	30x60
surface 2.0 charcoal	A09GZSUR-CBK.MoR	30x60	A09GZSUR-CBK.MoL	30x60
surface 2.0 copper	A09GZSUR-CPo.MoR	30x60	A09GZSUR-CPo.MoL	30x60

Surface 2.0

Nome	Codice Natural 	Formato(CM)	Codice Lappato 	Formato(CM)
surface 2.0 off white brick mosaic	AM-GZSUR-OW.RT/BRK	30x30	AM-GZSUR-OW.LP/BRK	30x30
surface 2.0 cool grey brick mosaic	AM-GZSUR-CG.RT/BRK	30x30	AM-GZSUR-CG.LP/BRK	30x30
surface 2.0 mid grey brick mosaic	AM-GZSUR-MG.RT/BRK	30x30	AM-GZSUR-MG.LP/BRK	30x30
surface 2.0 ash brick mosaic	AM-GZSUR-AS.RT/BRK	30x30	AM-GZSUR-AS.LP/BRK	30x30
surface 2.0 greige brick mosaic	AM-GZSUR-GE.RT/BRK	30x30	AM-GZSUR-GE.LP/BRK	30x30
surface 2.0 dark greige brick mosaic	AM-ZSUR-DGE.RT/BRK	30x30	AM-ZSUR-DGE.LP/BRK	30x30
surface 2.0 light sand brick mosaic	AM-ZSUR-LSN.RT/BRK	30x30	AM-ZSUR-LSN.LP/BRK	30x30
surface 2.0 sand brick mosaic	AM-GZSUR-SN.RT/BRK	30x30	AM-GZSUR-SN.LP/BRK	30x30
surface 2.0 clay brick mosaic	AM-GZSUR-CL.RT/BRK	30x30	AM-GZSUR-CL.LP/BRK	30x30
surface 2.0 charcoal brick mosaic	AM-GZSUR-CB.RT/BRK	30x30	AM-GZSUR-CB.LP/BRK	30x30

Nome	Codice Natural 	Formato(CM)
surface 2.0 off white mosaic 2.5x2.5	AM-GZSUR-OW.RT/2H	30x30
surface 2.0 cool grey mosaic 2.5x2.5	AM-GZSUR-CG.RT/2H	30x30
surface 2.0 mid grey mosaic 2.5x2.5	AM-GZSUR-MG.RT/2H	30x30
surface 2.0 ash mosaic 2.5x2.5	AM-GZSUR-AS.RT/2H	30x30
surface 2.0 greige mosaic 2.5x2.5	AM-GZSUR-GE.RT/2H	30x30
surface 2.0 dark greige mosaic 2.5x2.5	AM-GZSUR-DGE.RT/2H	30x30
surface 2.0 light sand mosaic 2.5x2.5	AM-GZSUR-LSN.RT/2H	30x30
surface 2.0 sand mosaic 2.5x2.5	AM-GZSUR-SN.RT/2H	30x30
surface 2.0 clay mosaic 2.5x2.5	AM-GZSUR-CL.RT/2H	30x30
surface 2.0 charcoal mosaic 2.5x2.5	AM-GZSUR-CB.RT/2H	30x30

Nome	Codice Natural 	Formato(CM)
surface 2.0 off white mosaic 3x6	AM-GZSUR-OW.RT3/6	30x30
surface 2.0 cool grey mosaic 3x6	AM-GZSUR-CG.RT3/6	30x30
surface 2.0 mid grey mosaic 3x6	AM-GZSUR-MG.RT3/6	30x30
surface 2.0 ash mosaic 3x6	AM-GZSUR-AS.RT3/6	30x30
surface 2.0 greige mosaic 3x6	AM-GZSUR-GE.RT3/6	30x30
surface 2.0 dark greige mosaic 3x6	AM-GZSUR-DGE.RT3/6	30x30
surface 2.0 light sand mosaic 3x6	AM-GZSUR-LSN.RT3/6	30x30
surface 2.0 sand mosaic 3x6	AM-GZSUR-SN.RT3/6	30x30
surface 2.0 clay mosaic 3x6	AM-GZSUR-CL.RT3/6	30x30
surface 2.0 charcoal mosaic 3x6	AM-GZSUR-CB.RT3/6	30x30

Nome	Codice Natural 	Formato(CM)	Codice Lappato 	Formato(CM)
surface 2.0 off white step	AST-09ZSUR-OWH.RA	30x60	AST-09ZSUR-OWH.LA	30x60
surface 2.0 cool grey step	AST-09ZSUR-CGY.RA	30x60	AST-09ZSUR-CGY.LA	30x60
surface 2.0 mid grey step	AST-09ZSUR-MGY.RA	30x60	AST-09ZSUR-MGY.LA	30x60
surface 2.0 ash step	AST-09ZSUR-ASo.RA	30x60	AST-09ZSUR-ASo.LA	30x60
surface 2.0 greige step	AST-09ZSUR-GEo.RA	30x60	AST-09ZSUR-GEo.LA	30x60
surface 2.0 dark greige step	AST-09ZSUR-DGE.RA	30x60	AST-09ZSUR-DGE.LA	30x60
surface 2.0 light sand step	AST-09ZSUR-LSN.RA	30x60	AST-09ZSUR-LSN.LA	30x60
surface 2.0 sand step	AST-09ZSUR-SNo.RA	30x60	AST-09ZSUR-SNo.LA	30x60
surface 2.0 clay step	AST-09ZSUR-CLo.RA	30x60	AST-09ZSUR-CLo.LA	30x60
surface 2.0 charcoal step	AST-09ZSUR-CBK.RA	30x60	AST-09ZSUR-CBK.LA	30x60

surface 2.0 off white battiscopa	ASKo6GZSUR-OWH.A8	7x60	ASKo6GZSUR-OWH.L8	7x60
surface 2.0 cool grey battiscopa	ASKo6GZSUR-CGY.A8	7x60	ASKo6GZSUR-CGY.L8	7x60
surface 2.0 mid grey battiscopa	ASKo6GZSUR-MGY.A8	7x60	ASKo6GZSUR-MGY.L8	7x60
surface 2.0 ash battiscopa	ASKo6GZSUR-ASo.A8	7x60	ASKo6GZSUR-ASo.L8	7x60
surface 2.0 greige battiscopa	ASKo6GZSUR-GEo.A8	7x60	ASKo6GZSUR-GEo.L8	7x60
surface 2.0 dark greige battiscopa	ASKo6GZSUR-DGE.A8	7x60	ASKo6GZSUR-DGE.L8	7x60
surface 2.0 light sand battiscopa	ASKo6GZSUR-LSN.A8	7x60	ASKo6GZSUR-LSN.L8	7x60
surface 2.0 sand battiscopa	ASKo6GZSUR-SNo.A8	7x60	ASKo6GZSUR-SNo.L8	7x60
surface 2.0 clay battiscopa	ASKo6GZSUR-CLo.A8	7x60	ASKo6GZSUR-CLo.L8	7x60
surface 2.0 charcoal battiscopa	ASKo6GZSUR-CBK.A8	7x60	ASKo6GZSUR-CBK.L8	7x60

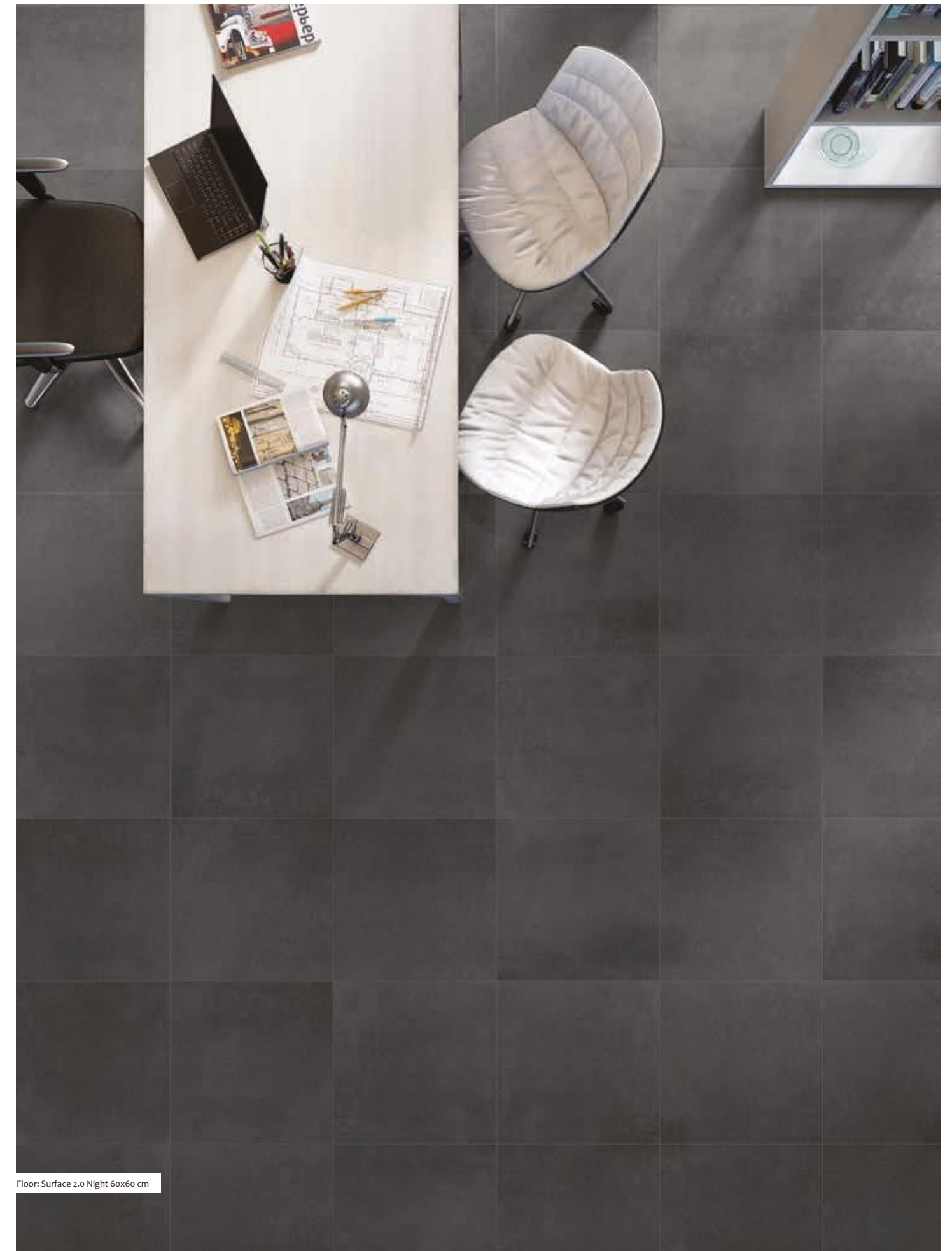

Floor: Surface 2.0 Night 60x60 cm

Surface 2.0 Outdoor



Floor: Surface 2.0 Outdoor Mid Grey 60x60 cm

CEMENTO

Surface 2.0 Outdoor



surface 2.0 outdoor mid grey

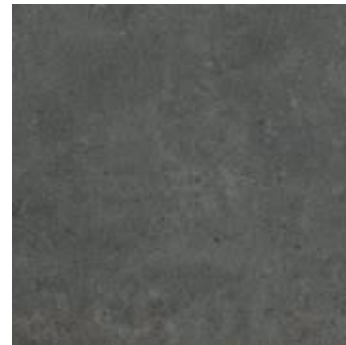

surface 2.0 outdoor ash

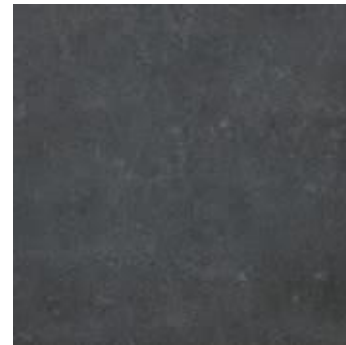

surface 2.0 outdoor night



surface 2.0 outdoor cool grey



surface 2.0 outdoor sand



surface 2.0 outdoor copper



surface 2.0 outdoor charcoal

Formati | Sizes | Formats | Formatos

60x60 cm

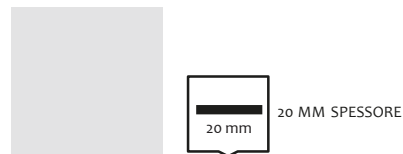

Price Codes

Formato(CM)	Outdoor
60x60	A20

Nome	Codice	Formato(CM)
surface 2.0 outdoor cool grey	A06GZSUR-CGY.MoT5R	60x60
surface 2.0 outdoor mid grey	A06GZSUR-MGY.MoT5R	60x60
surface 2.0 outdoor ash	A06GZSUR-ASo.MoT5R	60x60
surface 2.0 outdoor night	A06GZSUR-NTo.MoT5R	60x60
surface 2.0 outdoor sand	A06GZSUR-SNo.MoT5R	60x60
surface 2.0 outdoor copper	A06GZSUR-CPo.MoT5R	60x60
surface 2.0 outdoor charcoal	A06GZSUR-CBK.MoT5R	60x60

Formato (cm)	Spessore (mm)	Pezzi X	M ² X	Kg X	Eu. Pallet	M ² X Eu. Pallet	kg X Eu. Pallet
60x60	20	2	0,72	33,50	30	21,60	1005



Floor: Surface 2.0 Outdoor Ash 60x60 cm

Wall: Tokyo Concrete Grey 120x260 cm

Tokyo Concrete



tokyo concrete grey

Formati | Sizes | Formats | Formatos

120x260 cm

>| 6 mm

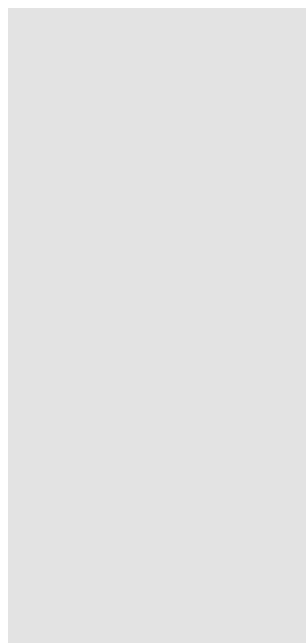

Price Codes

Formato(CM)	Natural
120x260	A36

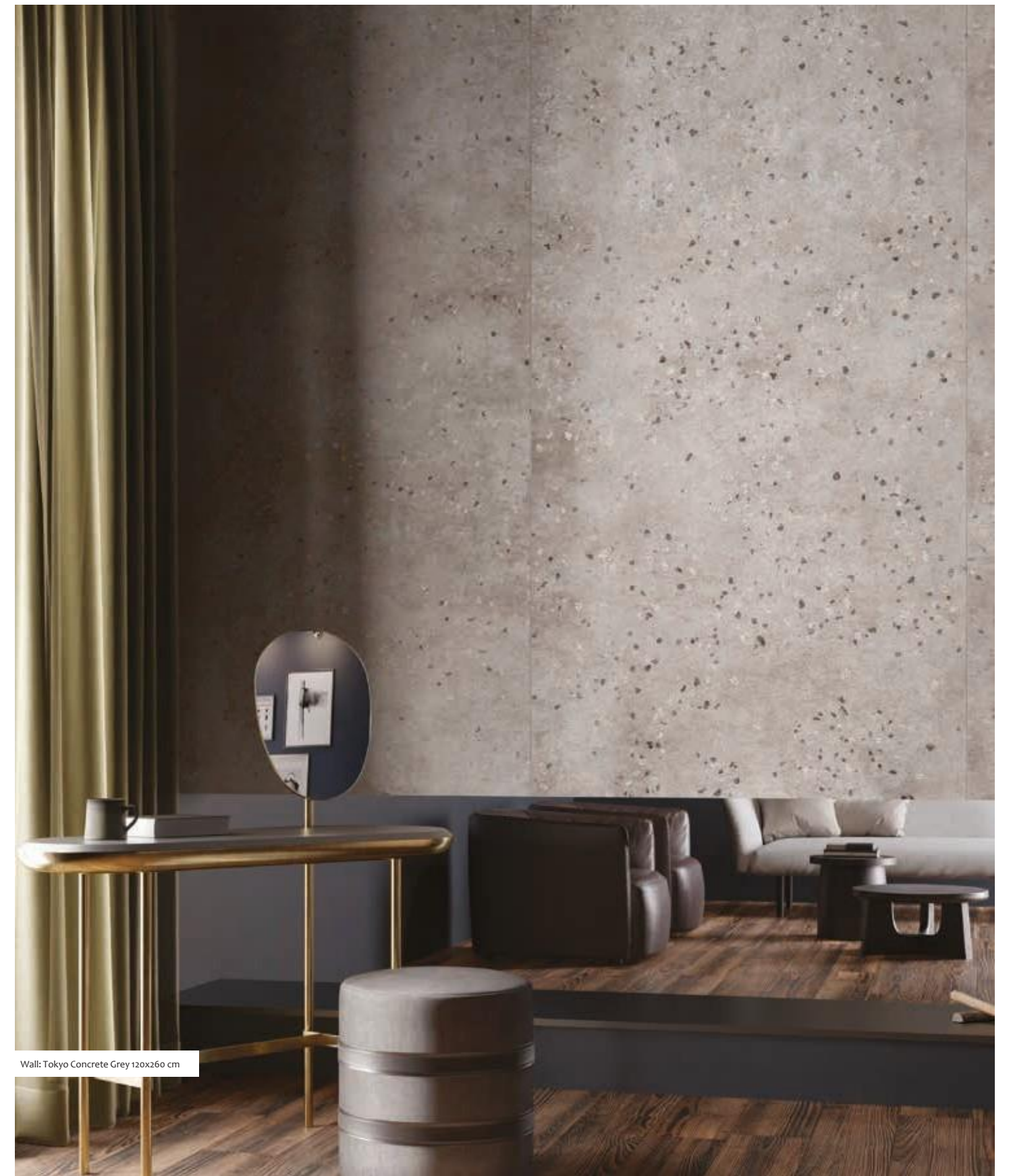

Nome	Spessore (MM)	Codice (Natural)	Formato(CM)
tokyo concrete grey	6	AGB62TYOCCRGZMSC6R	120x260

Formato (cm)	Spessore (mm)	Pezzi X	M ² X	Kg X	X Eu. Pallet	M ² X Eu. Pallet	kg X Eu. Pallet
120x260	6	1	3.12	48.00	20	62.40	960



Pietra

Niente di meglio per un ambiente rilassante.

reinterpreta il fascino ancestrale della pietra e lo trasforma in uno dei materiali preferiti dell'architettura contemporanea. Solide, resistenti ed estremamente versatili, le piastrelle effetto pietra sono dotate di caratteristiche tecniche uniche e di grande impatto visivo. Un materiale tradizionale in grado di conferire agli ambienti un aspetto contemporaneo. Le pietre Rak Ceramics si ispirano a vari tipi di pietra esistenti in natura e sono la scelta ideale per creare un'atmosfera particolarmente accogliente e adatta ad un ambiente sofisticato; donando una sensazione di benessere e relax.



Stone

No better way to create a relaxing environment.

RAK Ceramics reinterprets the ancestral charm of stone and transforms it to one of the most preferred materials in contemporary architecture. Solid, durable and extremely versatile, the stone-look tiles have special features and a highly attractive visual impact. A traditional mood that is able to define interior design projects with a modern appeal. RAK Ceramics' stone collection is inspired by various types of stone existing in nature and is the ideal choice to create a particularly welcoming atmosphere that suits a sophisticated environment; providing a sensation of wellness and relaxation.



Calcul

Rien de meilleur pour un espace relaxant.

RAK Ceramics réinterprète la fascination ancestrale de la pierre et la transforme en un des matériaux préférés de l'architecture contemporaine. Solides, résistants et extrêmement versatiles, les carreaux effet pierre sont dotés de caractéristiques techniques uniques et de grand effet visuel. Un matériel traditionnel, capable de conférer aux espaces un aspect contemporain. Les pierres RAK Ceramics s'inspirent aux divers types de pierre qui existent en nature, et constituent le choix idéal pour créer une atmosphère particulièrement conviviale, bien adapté à un espace sophistiqué, offrant une sensation de bien-être et de relax.



Piedra

No hay mejor manera de crear un ambiente relajante.

RAK Ceramics reinterpreta el encanto ancestral de la piedra y la transforma en uno de los materiales favoritos de la arquitectura contemporánea. Sólido, duradero y extremadamente versátil, las baldosas de aspecto piedra tienen características especiales y un impacto visual sumamente atractivo. Un estilo tradicional que permite definir los proyectos de diseño de interior con un encanto moderno. La colección piedra de RAK Ceramics se inspira en los varios tipos de piedra que existen en la naturaleza y es la elección ideal para crear ambientes especialmente acogedores que se adaptan a un entorno sofisticado, brindando una sensación de bienestar y relajación.

City Stone



Floor: City Stone Bone 30x60 cm

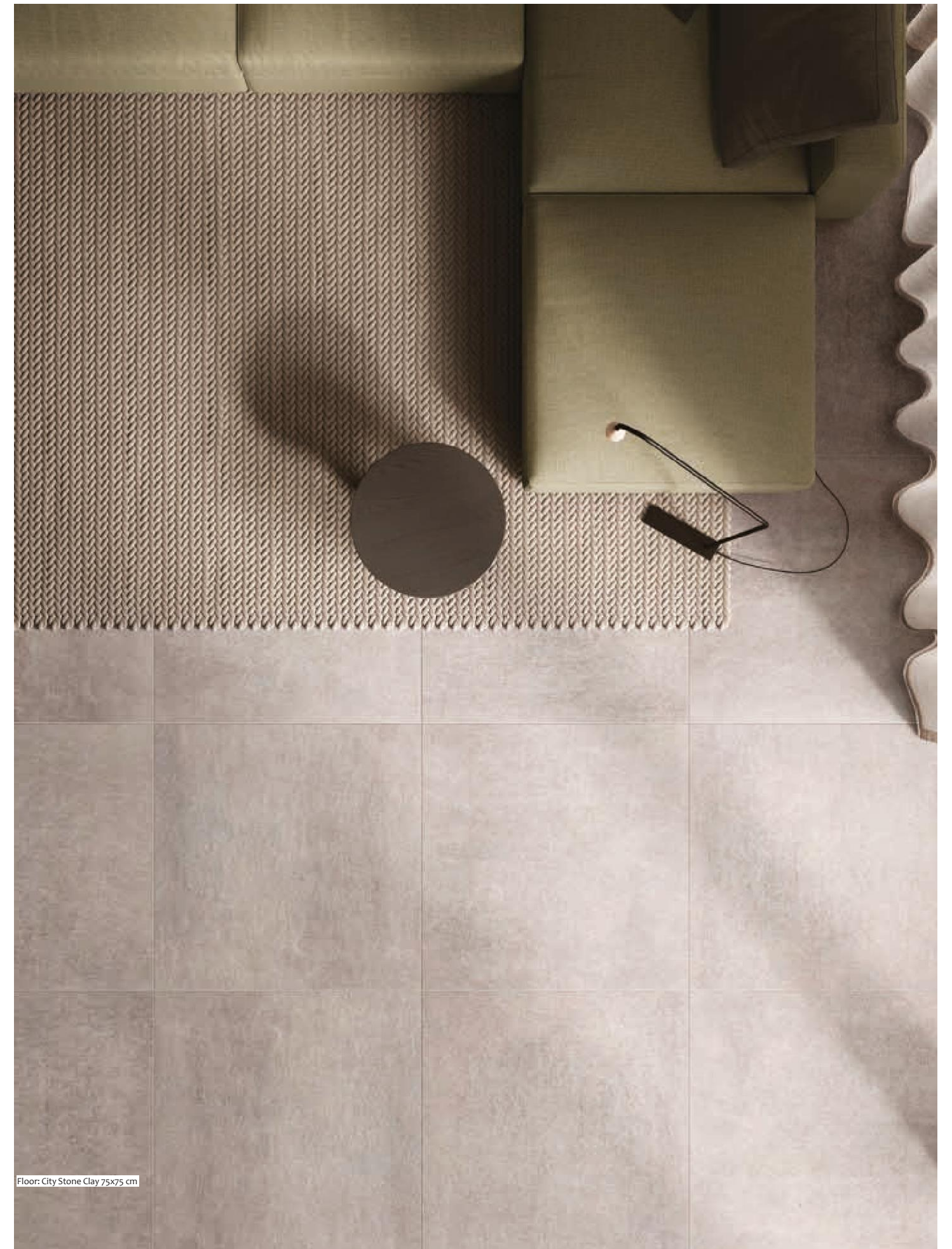

Floor: City Stone Clay 75x75 cm



City Stone

Wall: City Stone Grey 75x75 cm
Floor: City Stone Grey 75x75 cm.

PIETRA

City Stone

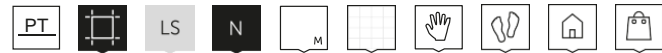

city stone bone



city stone grey



city stone anthracite



city stone clay

Formato (cm)	Spessore (mm)	Pezzi X	M ² X	Kg X	X Eu. Pallet	M ² X Eu. Pallet	kg X Eu. Pallet
75x75	9	2	1.12	25.00	45	50.40	1125.00
60x120	9	2	1.44	32.00	30	43.20	960.00
60x60	9	4	1.44	32.00	30	43.20	960.00
30x60	9	6	1.08	24.50	48	51.84	1176.00
Steps 30x60	8	8	1.44	20.52	40	57.6	820.80
Battiscopa 7x75	9	10	0.525	13.00	54	28.35	702.00
Battiscopa 7x60	9	15	0.63	15.00	48	30.24	720.00

Formati | Sizes | Formats | Formatos

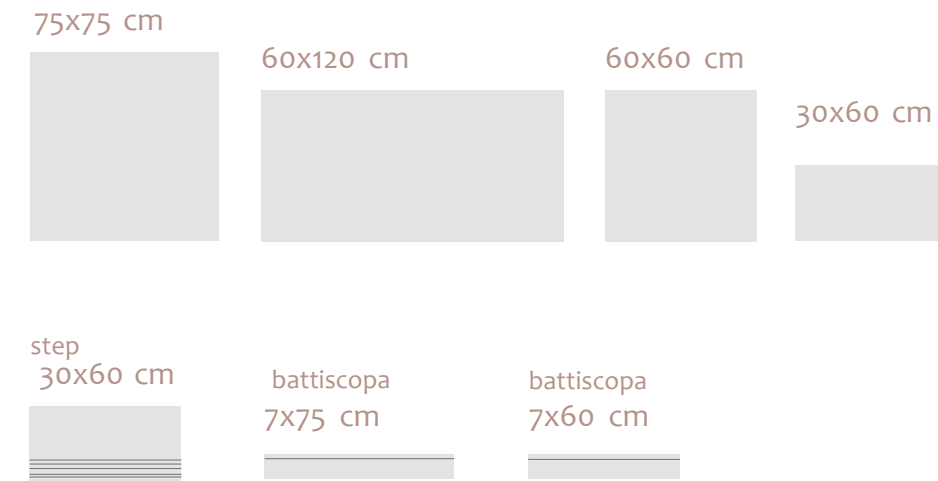

Price Codes

Formato(CM)	Natural
75X75	A9
60x120	A12
60X60	A6
30X60	A2
Step 30x120	B50
Step 30x60	B7
Battiscopa 7X75	B7
Battiscopa 7X60	B1

Nome	Codice	Formato(CM)	Codice	Formato(CM)	Codice	Formato(CM)	Codice	Formato(CM)
city stone anthracite	AGB75CTSEANTZMLS5R	75x75	AGB12CTSEANTZMLS5R	60x120	AGB06CTSEANTZMLNLR	60x60	AGB09CTSEANTZMLNLR	30x60
city stone bone	AGB75CTSEBNEZMLS5R	75x75	AGB12CTSEBNEZMLS5R	60x120	AGB06CTSEBNEZMLNLR	60x60	AGB09CTSEBNEZMLNLR	30x60
city stone grey	AGB75CTSEGRYZMLS5R	75x75	AGB12CTSEGRYZMLS5R	60x120	AGB06CTSEGRYZMLNLR	60x60	AGB09CTSEGRYZMLNLR	30x60
city stone clay	AGB75CTSECLAZMLS5R	75x75	AGB12CTSECLAZMLS5R	60x120	AGB06CTSECLAZMLNLR	60x60	AGB09CTSECLAZMLNLR	30x60

Nome	Codice	Formato(CM)	Nome	Codice	Formato(CM)
city stone anthracite step	AGTZZCTSEANT005671	30x60	city stone anthracite battiscopa	75CTS1N	7x75
city stone bone step	AGTZZCTSEBNE005673	30x60	city stone bone battiscopa	75CTS2N	7x75
city stone grey step	AGTZZCTSEGRY005675	30x60	city stone grey battiscopa	75CTS3N	7x75
city stone clay step	AGTZZCTSECLA005674	30x60	city stone clay battiscopa	75CTS4N	7x75
city stone anthracite battiscopa	60CTS5N	7x60			
city stone bone battiscopa	60CTS6N	7x60			
city stone grey battiscopa	60CTS7N	7x60			
city stone clay battiscopa	60CTS8N	7x60			

Curton



Floor: Curton beige 60x60 cm



Floor: Curton Grey Decor 60x60 cm



Curton

Floor: Curton Taupe 75x75 cm



curton white S



curton white decor R11 HS



curton taupe S



curton taupe decor R11 HS



curton grey S



curton grey decor R11 HS



curton beige S



curton beige decor R11 HS

Formati | Sizes | Formats | Formatos

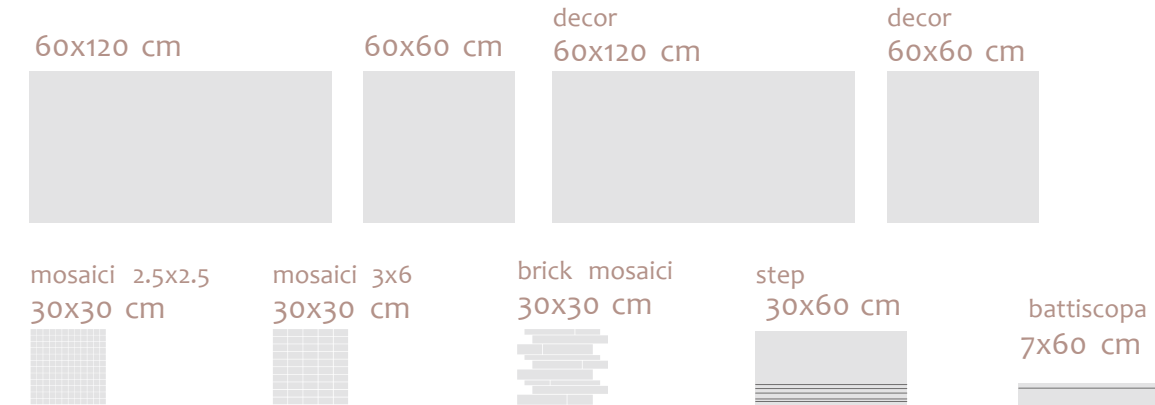

Price Codes

Formato(CM)	Natural
60x120	A16
Decor 60x120	A18
60x60	A13
Decor 60x60	A15
Step 30x120	B50
Step 30x60	B7
Battiscopa 7x60	B1
Mosaici 30x30	B9

Prodotti tecnici ad alte prestazioni

RAK Ceramics è sempre stata all'avanguardia nella proposta di prodotti tecnici in Gres Porcellanato a tutta massa. Oggi, grazie ad una innovata tecnologia produttiva dedicata, si aprono nuove prospettive nell'ambito dei grandi progetti, sia residenziali che commerciali.

High performance technical tiles

RAK Ceramics has always been at the forefront of Technical Gres Porcelain tiles. Thanks to the updated technology, RAK Ceramics opens up new perspectives in the field of major projects, both for residential and commercial, and reaffirms a brand of absolute value.

Produits techniques aux prestations élevées

De tout temps, RAK Ceramics a été à l'avant-garde de produits techniques en grès porcelaine pleine masse. Aujourd'hui, grâce à une technique productrice innovatrice, de nouvelles perspectives s'ouvrent dans le domaine de grands projets, résidentiels et commerciaux.

Baldosas técnicas de alto rendimiento

RAK Ceramics siempre ha estado a la vanguardia de las baldosas de porcelana de Technical Gres. Gracias a la tecnología actualizada, RAK Ceramics abre nuevas perspectivas en el campo de los grandes proyectos, tanto residenciales como comerciales, y reafirma una marca de absoluto valor.

Curton

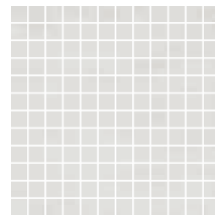

curton white mosaic 2.5x2.5 30x30 cm

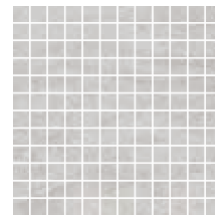

curton taupe mosaic 2.5x2.5 30x30 cm

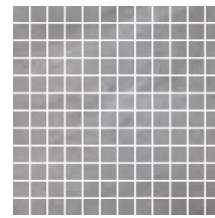

curton grey mosaic 2.5x2.5 30x30 cm

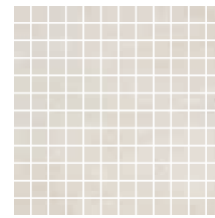

curton beige mosaic 2.5x2.5 30x30 cm



curton white mosaic 3x6 30x30 cm

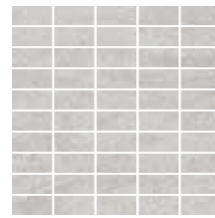

curton taupe mosaic 3x6 30x30 cm

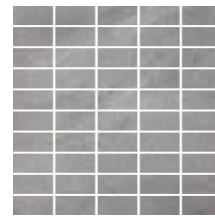

curton grey mosaic 3x6 30x30 cm

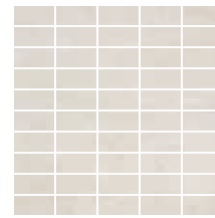

curton beige mosaic 3x6 30x30 cm



curton white brick mosaic 30x30 cm



curton taupe brick mosaic 30x30 cm

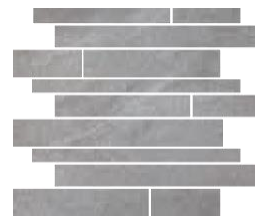

curton grey brick mosaic 30x30 cm



curton beige brick mosaic 30x30 cm

Nome	Codice	Formato(CM)	Nome	Codice	Formato(CM)
curton white	A2B12PDCNWHMMSS5R	60x120	curton white	A2B06PDCNWHMMSNLR	60x60
curton grey	A2B12PDCNGRYMMS5R	60x120	curton grey	A2B06PDCNGRYMMSNLR	60x60
curton taupe	A2B12PDCNTPEMMS5R	60x120	curton taupe	A2B06PDCNTPEMMSNLR	60x60
curton beige	A2B12PDCNBEMMS5R	60x120	curton beige	A2B06PDCNBEMMSNLR	60x60
curton white decor	A2D12PDCNWHMMLS5R	60x120	curton white decor	A2D06PDCNWHMMLN1R	60x60
curton grey decor	A2D12PDCNGRYMMLS5R	60x120	curton grey decor	A2D06PDCNGRYMMLN1R	60x60
curton taupe decor	A2D12PDCNTPEMMLS5R	60x120	curton taupe decor	A2D06PDCNTPEMMLN1R	60x60
curton beige decor	A2D12PDCNBEMMLS5R	60x120	curton beige decor	A2D06PDCNBEMMLN1R	60x60
curton white battiscopa	60PDC4	7x60	curton white step	ACTZZPDCNWH006758	30x60
curton grey battiscopa	60PDC2	7x60	curton grey step	ACTZZPDCNGRY006677	30x60
curton taupe battiscopa	60PDC3	7x60	curton taupe step	ACTZZPDCNTP006678	30x60
curton beige battiscopa	60PDC1	7x60	curton beige step	ACTZZPDCNBEE006676	30x60
curton white mosaic 2.5x2.5	AMPDC4N	30x30	curton white mosaic 3x6	AMPDC8N	30x30
curton taupe mosaic 2.5x2.5	AMPDC3N	30x30	curton taupe mosaic 3x6	AMPDC7N	30x30
curton grey mosaic 2.5x2.5	AMPDC2N	30x30	curton grey mosaic 3x6	AMPDC6N	30x30
curton beige mosaic 2.5x2.5	AMPDC1N	30x30	curton beige mosaic 3x6	AMPDC5N	30x30
curton white brick mosaic	AMPDC12N	30x30			
curton taupe brick mosaic	AMPDC11N	30x30			
curton grey brick mosaic	AMPDC10N	30x30			
curton beige brick mosaic	AMPDC9N	30x30			

Formato (cm)	Spessore (mm)	Pezzi X	M² X	Kg X	X Eu. Pallet	M² X Eu. Pallet	kg X Eu. Pallet
60x120	9	2	1.44	32.00	30	43.20	960.00
60x60	9	4	1.44	32.00	30	43.20	960.00
Mosaici 30x30	9	10	-	14.00	48	-	672.00
30x60	9	6	1.08	24.50	48	51.84	1176.00
Steps 30x60	8	8	1.44	20.52	40	57.6	820.80
Battiscopa 7x60	9	15	0.63	15.00	48	30.24	720.00

Lounge



Floor: Lounge Anthracite Polished 60x60 cm,
Lounge Light Black Polished 10x60 cm.



Wall: Lounge Beige 30x60 cm, Lounge Beige Mosaic 2,5x30 2,5x30 cm
Floor: Lounge Beige Smooth Matt 60x60 cm

Lounge



Floor: Lounge Anthracite 100x100cm

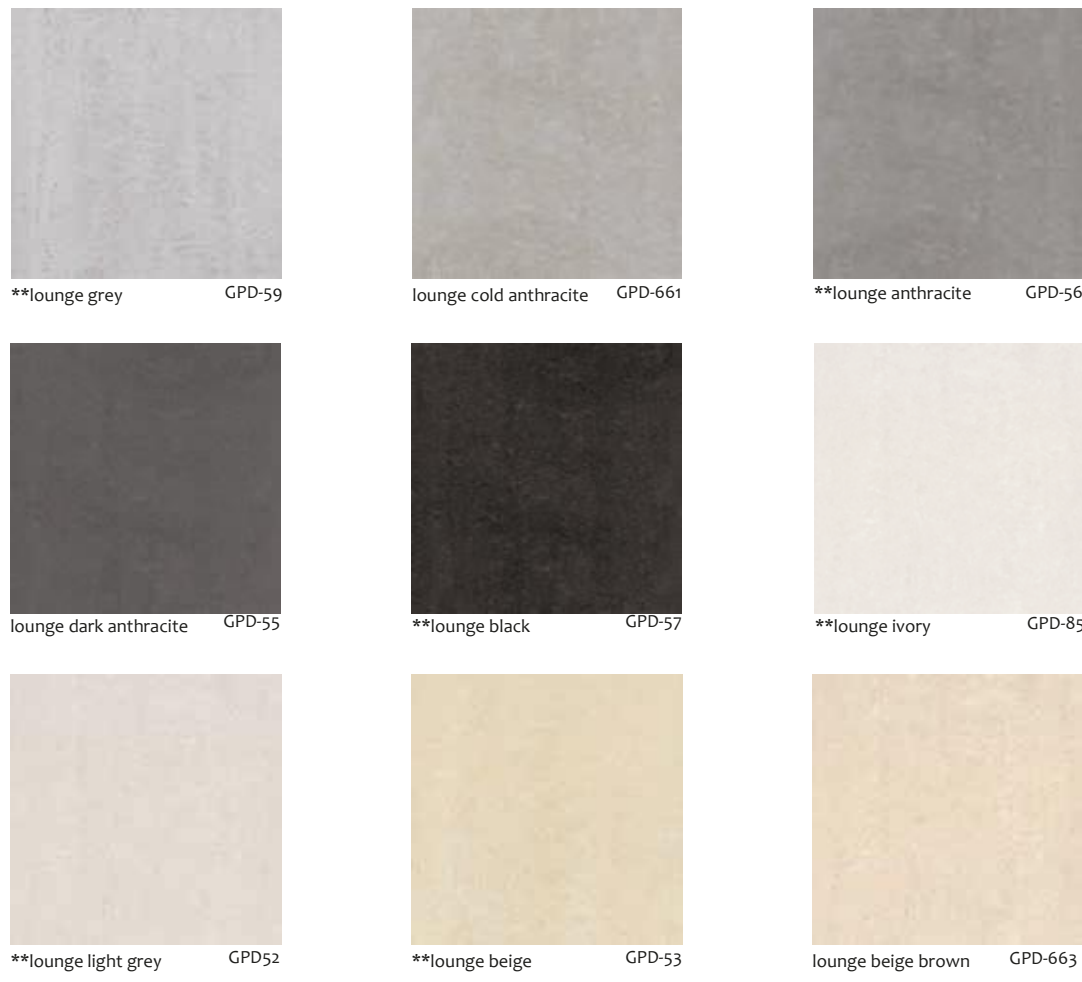
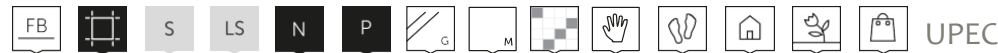

**Only available in: 100x100 cm in natural and polished

Formati | Sizes | Formats | Formatos

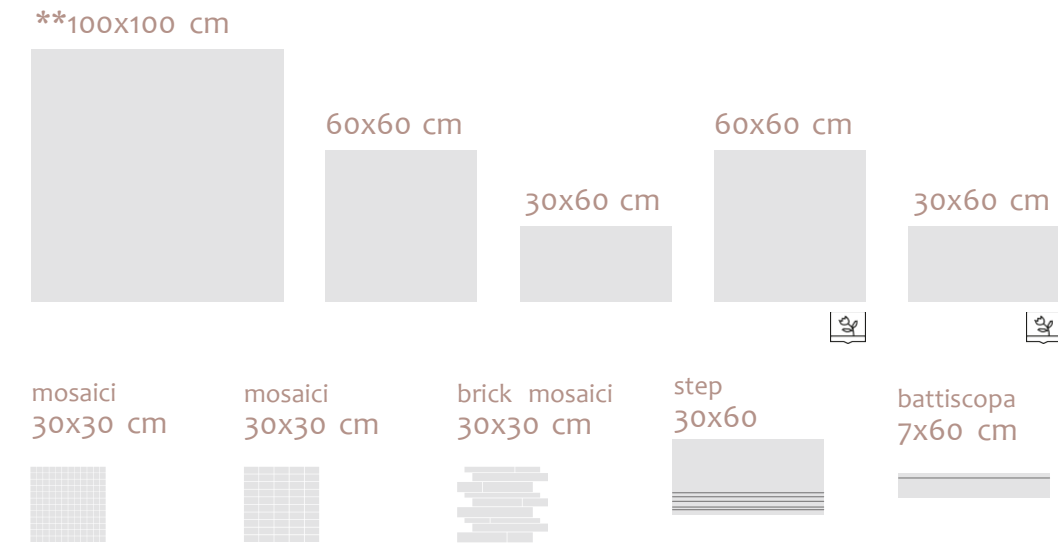

Finiture | Finishes | Finitions | Acabados



*Available in: 60x60 cm and 30x60 cm

Price Codes

Formato(CM)	Natural	Polished	Rustic
100x100	A17	A19	-
60x60	A10	A13	A12
30x60	A4	A8	A6

Formato(CM)	Natural	Polished	Rustic
Step 30x60	B7	-	-
Battiscopa 7X60	B1	B2	-
Mosaici 30x30	B9	B10	-

Formato (cm)	Spessore (mm)	Pezzi X	M² X	Kg X	X Eu. Pallet	M² X Eu. Pallet	kg X Eu. Pallet
100x100	12,5	2	2.00	60.00	20	40	1200
60x60	9	4	1.44	32.00	30	43.20	960.00
30x60	9	6	1.08	24.50	48	51.84	1176.00
Mosaici 30x30	9	10	-	14.00	48	-	672.00
Steps 30x60	8	8	1.44	20.52	40	57.6	820.80
Battiscopa 7x60	9	15	0.63	15.00	48	30.24	720.00

Prodotti tecnici ad alte prestazioni

RAK Ceramics è sempre stata all'avanguardia nella proposta di prodotti tecnici in Gres Porcellanato a tutta massa. Oggi, grazie ad una innovata tecnologia produttiva dedicata, si aprono nuove prospettive nell'ambito dei grandi progetti, sia residenziali che commerciali.



High performance technical tiles

RAK Ceramics has always been at the forefront of Technical Gres Porcelain tiles. Thanks to the updated technology, RAK Ceramics opens up new perspectives in the field of major projects, both for residential and commercial, and reaffirms a brand of absolute value.



Produits techniques aux prestations élevées

De tout temps, RAK Ceramics a été à l'avant-garde de produits techniques en grès porcelaine pleine masse. Aujourd'hui, grâce à une technique productrice innovatrice, de nouvelles perspectives s'ouvrent dans le domaine de grands projets, résidentiels et commerciaux.



Baldosas técnicas de alto rendimiento

RAK Ceramics siempre ha estado a la vanguardia de las baldosas de porcelana de Technical Gres. Gracias a la tecnología actualizada, RAK Ceramics abre nuevas perspectivas en el campo de los grandes proyectos, tanto residenciales como comerciales, y reafirma una marca de absoluto valor.

Lounge

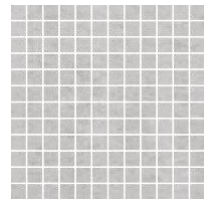

lounge grey mosaic 2.5x2.5 30x30 cm

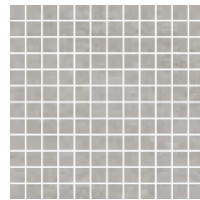

lounge cold anthracite mosaic 2.5x2.5 30x30 cm

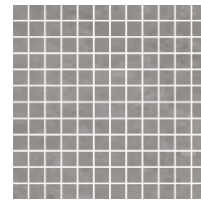

lounge anthracite mosaic 2.5x2.5 30x30 cm

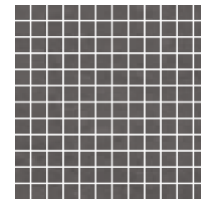

lounge dark anthracite mosaic 2.5x2.5 30x30 cm

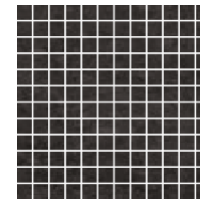

lounge black mosaic 2.5x2.5 30x30 cm

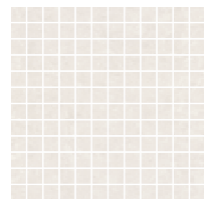

lounge ivory mosaic 2.5x2.5 30x30 cm

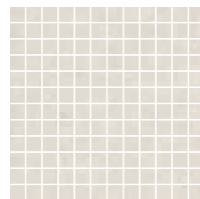

lounge light grey mosaic 2.5x2.5 30x30 cm

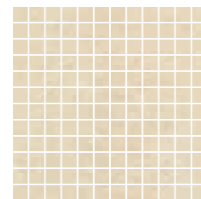

lounge beige mosaic 2.5x2.5 30x30 cm

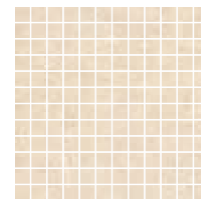

lounge beige brown mosaic 2.5x2.5 30x30 cm



lounge grey mosaic 3x6 30x30 cm



lounge cold anthracite mosaic 3x6 30x30 cm



lounge anthracite mosaic 3x6 30x30 cm

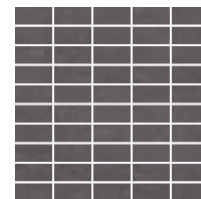

lounge dark anthracite mosaic 3x6 30x30 cm

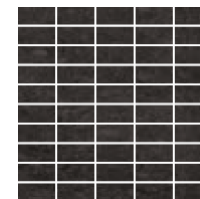

lounge black mosaic 3x6 30x30 cm

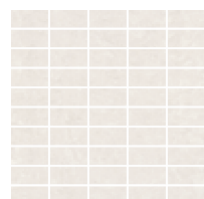

lounge ivory mosaic 3x6 30x30 cm

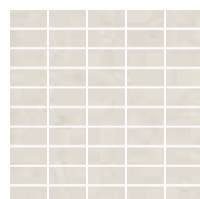

lounge light grey mosaic 3x6 30x30 cm

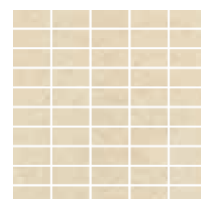

lounge beige mosaic 3x6 30x30 cm

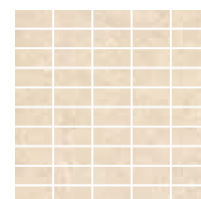

lounge beige brown mosaic 3x6 30x30 cm

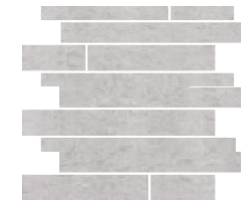

lounge grey brick mosaic 30x30 cm



lounge cold anthracite brick mosaic 30x30 cm



lounge anthracite brick mosaic 30x30 cm

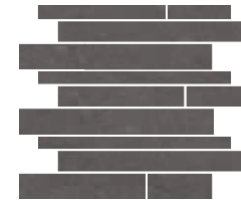

lounge dark anthracite brick mosaic 30x30 cm

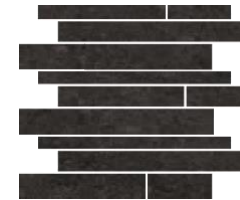

lounge black brick mosaic 30x30 cm

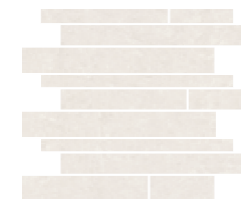

lounge ivory brick mosaic 30x30 cm



lounge light grey brick mosaic 30x30 cm



lounge beige brick mosaic 30x30 cm







lounge beige brown brick mosaic 30x30 cm

Nome	Natural	Codice	Formato(CM)	Nome	Natural	Codice	Formato(CM)
lounge grey mosaic 2.5x2.5		AM-7GPD-59UP/A	30x30	lounge grey mosaic 3x6		AM-GPD-59UP3/6	30x30
lounge cold anthracite mosaic 2.5x2.5		AM-GPD-661UPM/2H	30x30	lounge cold anthracite mosaic 3x6		AM-GPD-661UPM3/6	30x30
lounge anthracite mosaic 2.5x2.5		AM-GPD-56UP/A	30x30	lounge anthracite mosaic 3x6		AM-7GPD-56UP	30x30
lounge dark anthracite mosaic 2.5x2.5		AM-GPD-55UP	30x30	lounge dark anthracite mosaic 3x6		AM-GPD-555UP3/6	30x30
lounge black mosaic 2.5x2.5		AM-7GPD-57UP	30x30	lounge black mosaic 3x6		AM-GPD-57UP	30x30
lounge ivory mosaic 2.5x2.5		AM-GPD-85UPM/2H	30x30	lounge ivory mosaic 3x6		AM-GPD-085UP	30x30
lounge light grey mosaic 2.5x2.5		AM-GPD-52UP	30x30	lounge light grey mosaic 3x6		AM-GPD-52UP/A	30x30
lounge beige mosaic 2.5x2.5		AM-7GPD-53UP	30x30	lounge beige mosaic 3x6		AM-GPD-53UP	30x30
lounge beige brown mosaic 2.5x2.5		AM-GPD-665UP/2H	30x30	lounge beige brown mosaic 3x6		AM-GPD-663UP	30x30



Nome	Natural	Codice	Formato(CM)
lounge grey brick mosaic		AM-GPD-59UP10/10	30x30
lounge cold anthracite brick mosaic		AM-GPD-661UP10/10	30x30
lounge anthracite brick mosaic		AM-GPD-56UP10/10	30x30
lounge dark anthracite brick mosaic		AM-GPD-55UP10/10	30x30
lounge black brick mosaic		AM-GPD-57UP10/10	30x30
lounge ivory brick mosaic		AM-GPD-85UP10/10	30x30
lounge light grey brick mosaic		AM-GPD-52UP10/10	30x30
lounge beige brick mosaic		AM-GPD-53UP10/10	30x30
lounge beige brown brick mosaic		AM-GPD-665UP10/10	30x30

Lounge



Nome	Codice Natural 	Formato(CM)	Codice Polished 	Formato(CM)	Codice Rustic  	Formato(CM)
lounge grey	A06GLOUN-059.UoR	60x60	A06GLOUN-059.XoP	60x60	A06GLOUN-059.U2R	60x60
lounge cold anthracite	A06GLOUN-660.UoR	60x60	A06GLOUN-660.XoP	60x60	A06GLOUN-660.U2R	60x60
lounge anthracite	A06GLOUN-056.UoR	60x60	A06GLOUN-056.XoP	60x60	A06GLOUN-056.U2R	60x60
lounge dark anthracite	A06GLOUN-055.UoR	60x60	A06GLOUN-055.XoP	60x60	A06GLOUN-055.U2R	60x60
lounge black	A06GLOUN-057.UoR	60x60	A06GLOUN-057.XoP	60x60	A06GLOUN-057.U2R	60x60
lounge ivory	A06GLOUN-085.UoR	60x60	A06GLOUN-085.XoP	60x60	A06GLOUN-085.U2R	60x60
lounge light grey	A06GLOUN-052.UoR	60x60	A06GLOUN-052.XoP	60x60	A06GLOUN-052.U2R	60x60
lounge beige	A06GLOUN-053.UoR	60x60	A06GLOUN-053.XoP	60x60	A06GLOUN-053.U2R	60x60
lounge beige brown	A06GLOUN-663.UoR	60x60	A06GLOUN-663.XoP	60x60	A06GLOUN-663.U2R	60x60

lounge grey	A09GLOUN-059.UoR	30x60	A09GLOUN-059.XoP	30x60	A09GLOUN-059.U2R	30x60
lounge cold anthracite	A09GLOUN-660.UoR	30x60	A09GLOUN-660.XoP	30x60	A09GLOUN-660.U2R	30x60
lounge anthracite	A09GLOUN-056.UoR	30x60	A09GLOUN-056.XoP	30x60	A09GLOUN-056.U2R	30x60
lounge dark anthracite	A09GLOUN-055.U2R	30x60	A09GLOUN-055.XoP	30x60	A09GLOUN-055.U2R	30x60
lounge black	A09GLOUN-057.UoR	30x60	A09GLOUN-057.XoP	30x60	A09GLOUN-057.U2R	30x60
lounge ivory	A09GLOUN-085.UoR	30x60	A09GLOUN-085.XoP	30x60	A09GLOUN-085.U2R	30x60
lounge light grey	A09GLOUN-052.UoR	30x60	A09GLOUN-052.XoP	30x60	A09GLOUN-052.U2R	30x60
lounge beige	A09GLOUN-053.UoR	30x60	A09GLOUN-053.XoP	30x60	A09GLOUN-053.U2R	30x60
lounge beige brown	A09GLOUN-663.UoR	30x60	A09GLOUN-663.XoP	30x60	A09GLOUN-663.U2R	30x60

lounge grey	A01GLOUN-059.UoR	100x100	A01GLOUN-059.XoP	100x100		
lounge anthracite	A01GLOUN-056.UoR	100x100	A01GLOUN-056.XoP	100x100		
lounge black	A01GLOUN-057.UoR	100x100	A01GLOUN-057.XoP	100x100		
lounge ivory	A01GLOUN-085.UoR	100x100	A01GLOUN-085.XoP	100x100		
lounge light grey	A01GLOUN-052.UoR	100x100	A01GLOUN-052.XoP	100x100		
lounge beige	A01GLOUN-053.UoR	100x100	A01GLOUN-053.XoP	100x100		

Nome	Codice Natural 	Formato(CM)	Codice Polished 	Formato(CM)
lounge grey battiscopa	60LOU6N	7x60	60LOU6P	7x60
lounge cold anthracite battiscopa	60LOU8N	7x60	60LOU8P	7x60
lounge anthracite battiscopa	60LOU3N	7x60	60LOU3P	7x60
lounge dark anthracite battiscopa	60LOU4N	7x60	60LOU4P	7x60
lounge black battiscopa	60LOU5N	7x60	60LOU5P	7x60
lounge ivory battiscopa	60LOU7N	7x60	60LOU7P	7x60
lounge light grey battiscopa	60LOU1N	7x60	60LOU1P	7x60
lounge beige battiscopa	60LOU2N	7x60	60LOU2P	7x60
lounge beige brown battiscopa	60LOU10N	7x60	60LOU10P	7x60

lounge grey step	AST-09LOUN-059.RA	30x60	AST-09LOUN-059.PA	30x60
lounge cold anthracite step	AST-09LOUN-661.RG	30x60	AST-09LOUN-661.PA	30x60
lounge anthracite step	AST-09LOUN-056.RE	30x60	AST-09LOUN-054.PA	30x60
lounge dark anthracite step	AST-09LOUN-055.RD	30x60	AST-09LOUN-055.PA	30x60
lounge black step	AST-09LOUN-057.RB	30x60	AST-09LOUN-057.PA	30x60
lounge ivory step	AST-09LOUN-085.RI	30x60	AST-09LOUN-085.PA	30x60
lounge light grey step	AST-09LOUN-052.RH	30x60	AST-09LOUN-052.PA	30x60
lounge beige step	AST-09LOUN-053.RJ	30x60	AST-09LOUN-053.PA	30x60
lounge beige brown step	AST-09LOUN-663.RK	30x60	AST-09LOUN-663.PA	30x60

Nome	Codice Natural 	Formato(CM)	Codice Natural 	Formato(CM)
lounge grey	-	60x60	-	30x60
lounge cold anthracite	-	60x60	-	30x60
lounge anthracite	-	60x60	-	30x60
lounge dark anthracite	-	60x60	-	30x60
lounge black	-	60x60	-	30x60
lounge ivory	-	60x60	-	30x60
lounge light grey	-	60x60	-	30x60
lounge beige	-	60x60	-	30x60
lounge beige brown	-	60x60	-	30x60

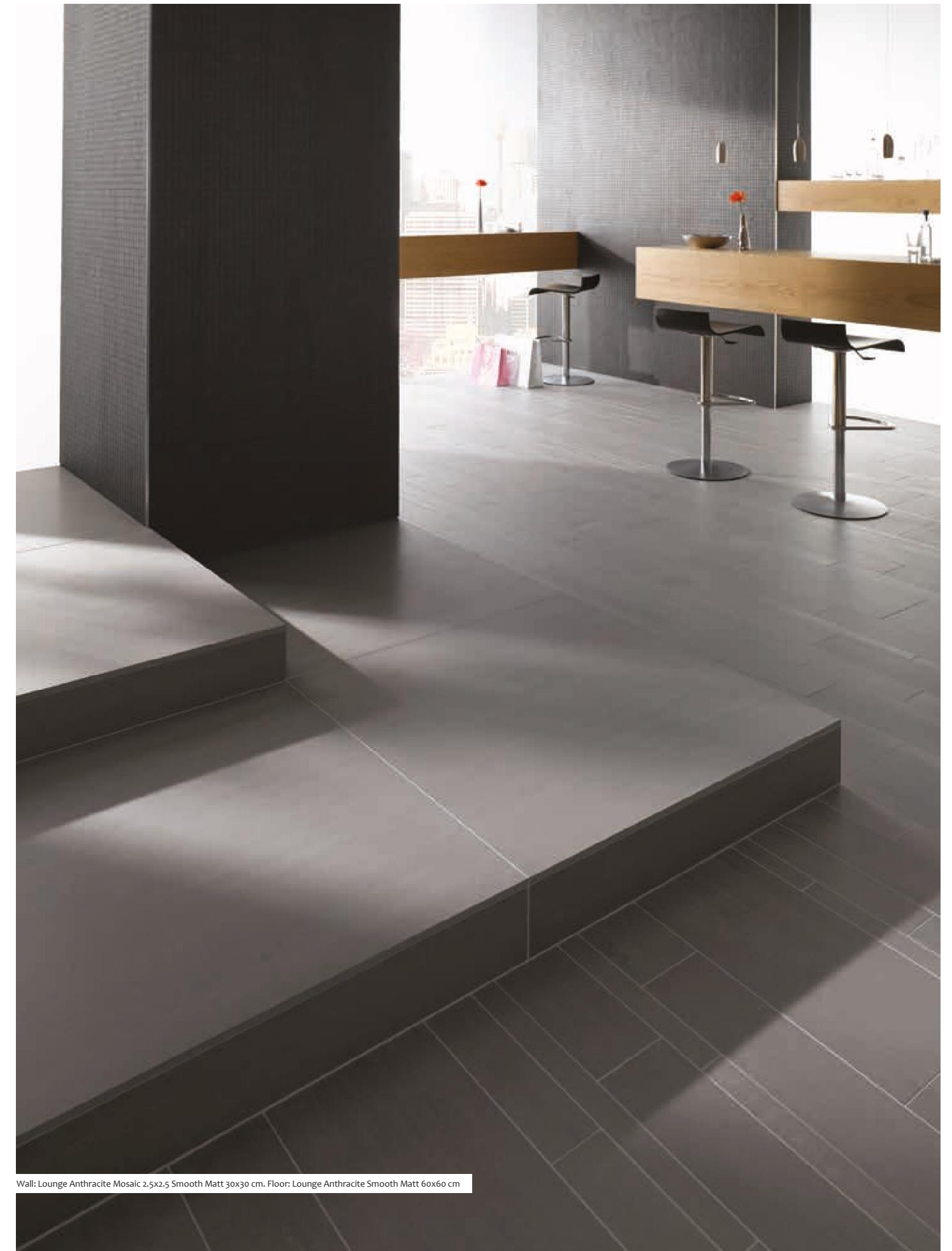

Wall: Lounge Anthracite Mosaic 2.5x2.5 Smooth Matt 30x30 cm. Floor: Lounge Anthracite Smooth Matt 60x60 cm

PIETRA

Maremma

SIGNATURE
COLLECTION



Floor: Maremma Dark Brown 75x75 cm

Maremma



Floor: Maremma Steel 75x75 cm

SIGNATURE
COLLECTION

Maremma



Floor: Maremma Grey 75x75 cm

Maremma

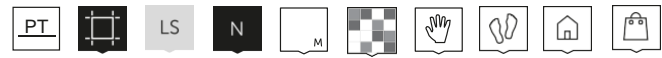

maremma steel



maremma grey



maremma sand



maremma dark brown



maremma copper



maremma orange



maremma cotto

Formati | Sizes | Formats | Formatos

75x75 cm

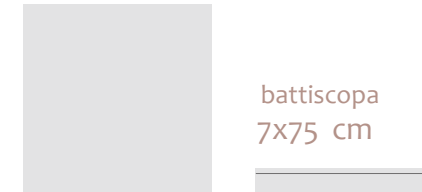

battiscopa
7x75 cm

Price Codes

Formato(CM)	Natural
75x75	A9
Step 30x120	B50
Battiscopa 7X75	B2

Nome	Codice	Formato(CM)	Nome	Codice	Formato(CM)
maremma steel	AGB75MRMASTEZMLS5R	75X75	maremma steel battiscopa	75MRM4N	7x75
maremma copper	AGB75MRMACOPZMLS5R	75X75	maremma copper battiscopa	75MRM2N	7x75
maremma grey	AGB75MRMAGRYZMLS5R	75X75	maremma grey battiscopa	75MRM3N	7x75
maremma sand	AGB75MRMASNDZMLS5R	75X75	maremma sand battiscopa	75MRM1N	7x75
maremma dark brown	AGB75MRMADBRZMLS5R	75X75	maremma dark brown battiscopa	75MRM8N	7x75
maremma orange	AGB12MRMAOREZMLS5R	75X75	maremma orange battiscopa	75MRM5N	7x75
maremma cotto	AGB75MRMASNDZMLS5R	75X75	maremma cotto battiscopa	75MRM7N	7x75

Formato (cm)	Spessore (mm)	Pezzi X	M² X	Kg X	X Eu. Pallet	M² X Eu. Pallet	kg X Eu. Pallet
75x75	9	2	1,12	25,00	45	50,40	1125,00
Battiscopa 7x75	9	10	0,525	13,00	54	28,35	702



Rivestimenti

L'unico limite e' l'immaginazione

Grazie alla continua innovazione tecnologica, e' oggi possibile riprodurre in ceramica qualsiasi tipo di superficie: legno naturale, carta da parati, metalli, cemento ed altri tipi di rivestimento.

Le nostre nuove collezioni ceramiche incontrano le ultime tendenze, con risultati estetici originali e accattivanti, disponibili in una vasta gamma di strutture e colori, dal pastello all'effetto materico più intenso.

La gamma di possibilità diventa ancora più ampia, grazie alla vasta scelta di formati, dal piccolo brick ai più grandi formati. È semplicemente ceramica. Ed è fantastica!



Ceramic Wall Tiles

The only limit is imagination.

With the continuous innovation in ceramic technology and research, all type of surfaces can now be reproduced : natural wood effect, ceramic wallpaper, metal effect, concrete coatings and more.

Our new ceramic tile collections meet the latest trends, achieving original and eye-catching aesthetic results, with a wide range of structures and colors: from the latest pastel tones to the most intense material effects.

The range of possibilities becomes even bigger, thanks to the wide choice of sizes, from the small brick to the large tile. It's ceramics, and it's cool!



Revêtement

L'unique limite est l'imaginaton

Grâce à l'innovation technologique continue, il est possible, aujourd'hui, de reproduire en céramique n'importe quel type de surface: le bois naturel, le papier peint, les métaux, le ciment et d'autres types de revêtement.

Nos nouvelles collections céramiques rencontrent les tendances les plus récentes, avec des résultats esthétiques originaux et captivants, disponibles dans une vaste gamme de structures et de couleurs, du pastel à l'effet matériel le plus intensif.

La gamme de possibilités devient encore plus vaste, grâce au grand choix de formats, du petit brick aux plus grands formats. C'est tout simplement la céramique. Et elle est fantastique!



Rivestimento

El único límite es la imaginación

Gracias a la continua innovación tecnológica, ahora es posible reproducir cualquier tipo de superficie en cerámica: madera natural, papel tapiz, metales, hormigón y otros tipos de revestimiento.

Nuestras nuevas colecciones de cerámica responden a las últimas tendencias, con resultados estéticos originales y atractivos, disponibles en una vasta gama de estructuras y colores, desde el pastel hasta el efecto materico más intenso.

La gama de posibilidades se amplía aún más, gracias a la gran variedad de formatos, desde el pequeño ladrillo hasta los formatos más grandes. Es simplemente cerámica. ¡Y es genial!

Aquarela

SIGNATURE
COLLECTION

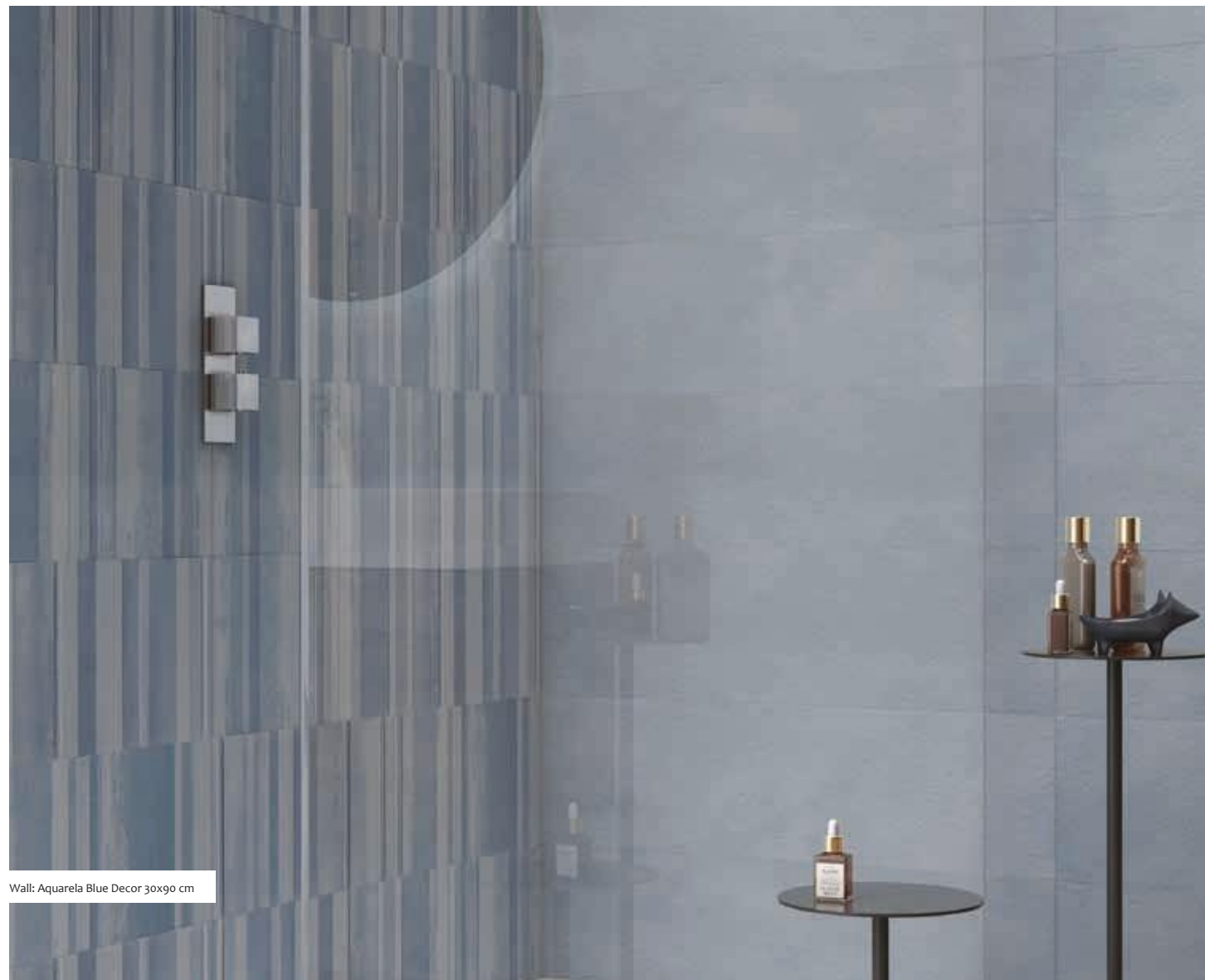

Wall: Aquarela Blue Decor 30x90 cm

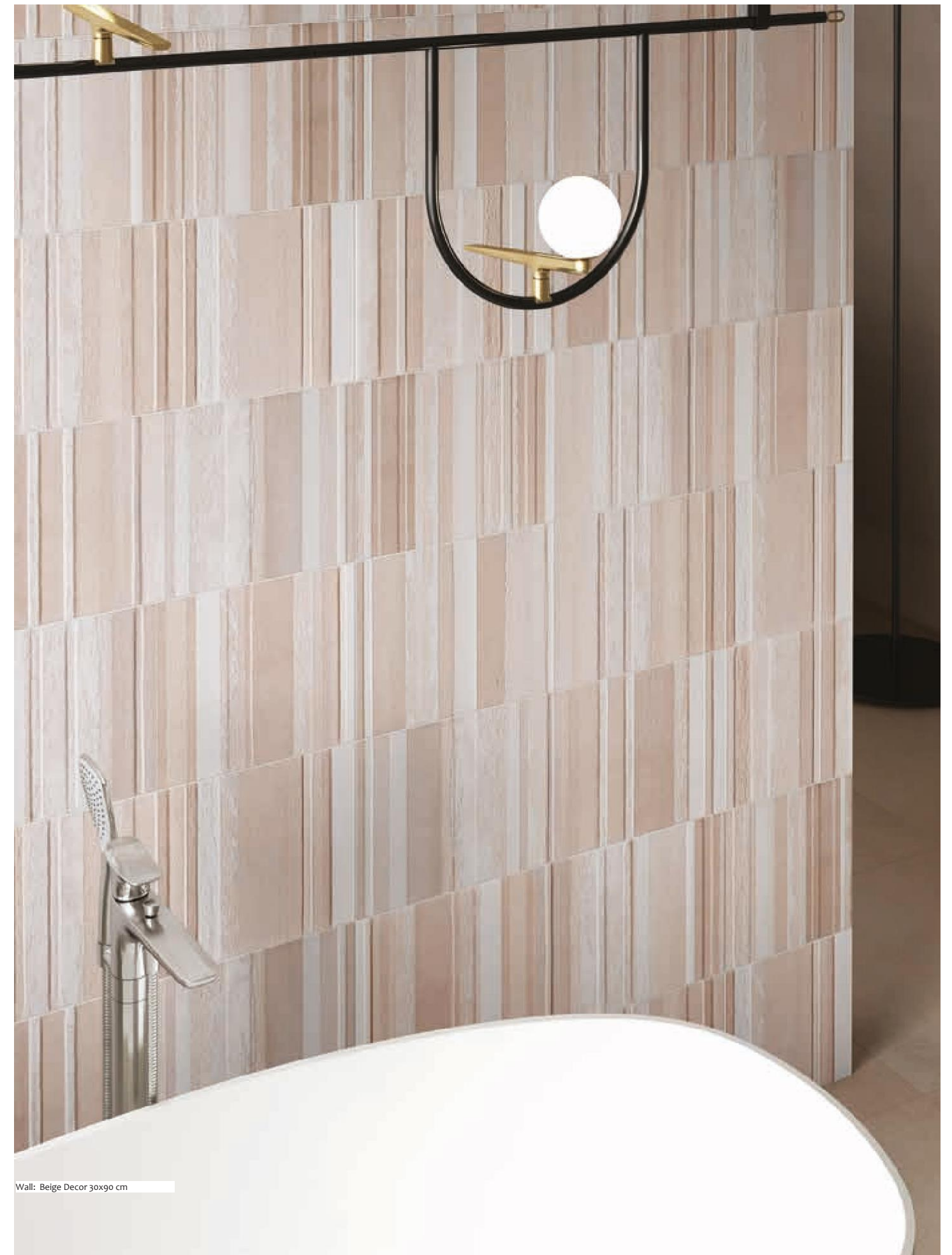

Wall: Beige Decor 30x90 cm

SIGNATURE
COLLECTION

Aquarela

Wall: Aquarela Grey Decor 30x90 cm
Floor: Revive Concrete Blade Beige 60x60 cm



aquarela white LS



aquarela beige LS



aquarela grey LS



aquarela blue LS



aquarela beige decor HS



aquarela grey decor HS



aquarela blue decor HS

Formati | Sizes | Formats | Formatos

30x90 cm

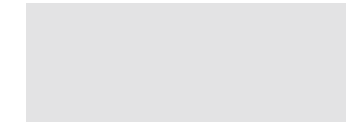

Price Codes

Formato(CM)	Plain	Decor
30x90	A3	A6

Nome	Codice	Formato(CM)
aquarela white	ARB43AQLAWHEZMLNLR	30x90
aquarela beige	ARB43AQLABEEZMLNLR	30x90
aquarela grey	ARB43AQLAGRYZMLNLR	30x90
aquarela blue	ARB43AQLABLEZMLNLR	30x90
aquarela beige decor	ARD43AQLABEEZMLN2R	30x90
aquarela grey decor	ARD43AQLAGRYZMLN2R	30x90
aquarela blue decor	ARD43AQLABLEZMLN2R	30x90

Formato (cm)	Spessore (mm)	Pezzi X	M ² X	Kg X	X Eu. Pallet	M ² X Eu. Pallet	Kg X Eu. Pallet
30x90	10.5	7	1.89	35.00	32	-	1120.00

Fabric Concrete

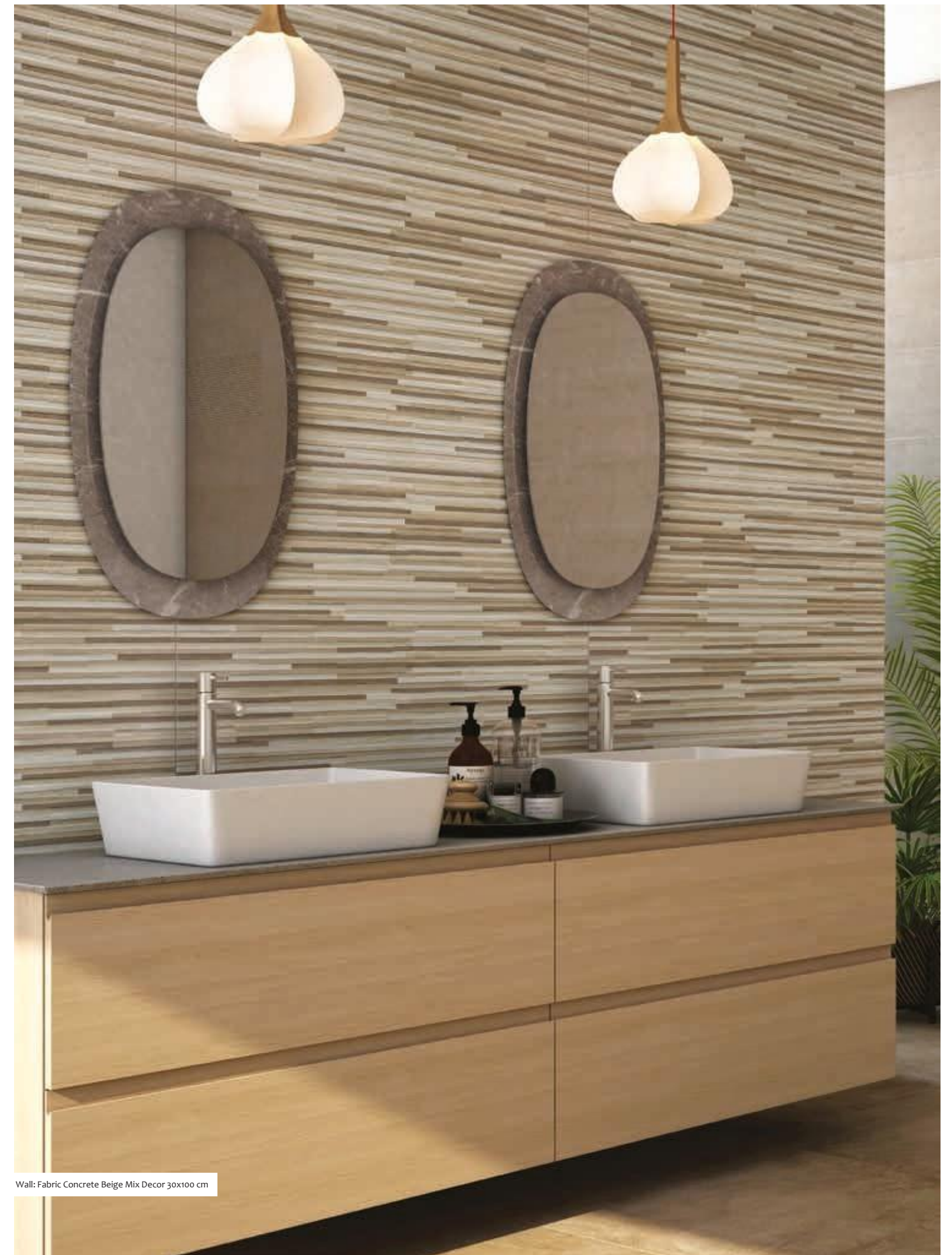

Fabric Concrete



Wall: Fabric Concrete Light Grey 30x100 cm, Fabric Concrete Light Grey Line Decor 30x100 cm, Fabric Concrete Grey Mix Decor 30x100 cm. Floor: Basic Concrete Dark Grey 30x60 cm

Fabric Concrete

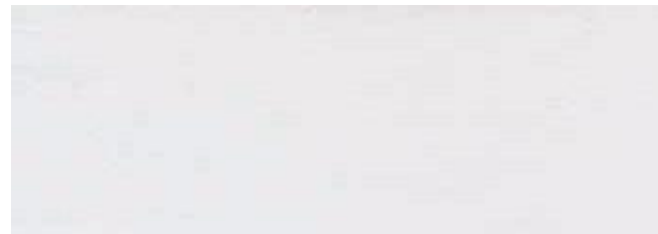

fabric concrete light grey



fabric concrete light grey line decor

LS



fabric concrete grey

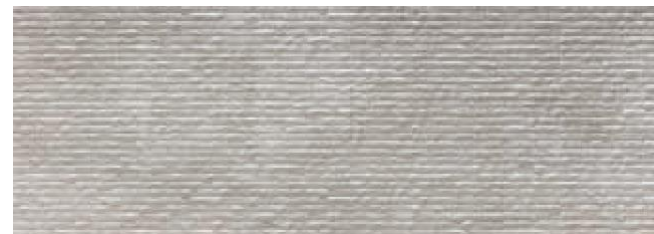

fabric concrete grey line decor

LS



fabric concrete beige



fabric concrete beige line decor

LS



fabric concrete brown



fabric concrete brown line decor

LS



fabric concrete grey mix decor

LS



fabric concrete beige mix decor

LS

Formati | Sizes | Formats | Formatos

30X100 cm

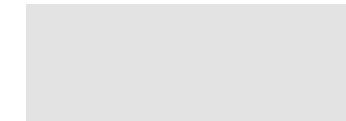

Price Codes

Formato(CM)	Plain	Decor
30x100	A3	A6

Nome	Codice	Formato(CM)	Nome	Codice	Formato(CM)
fabric concrete light grey	A31RZFBC-LGY.MoR	30x100	fabric concrete light grey line decor	A31RZFBC-LGY.MLR	30x100
fabric concrete grey	A31RZFBC-GYo.MoR	30x100	fabric concrete grey line decor	A31RZFBC-GYo.MLR	30x100
fabric concrete beige	A31RZFBC-BEo.MoR	30x100	fabric concrete beige line decor	A31RZFBC-BEo.MLR	30x100
fabric concrete brown	A31RZFBC-BRo.MoR	30x100	fabric concrete brown line decor	A31RZFBC-BRo.MLR	30x100
fabric concrete grey mix decor	A31RZFBC-MX1.MDR	30x100			
fabric concrete beige mix decor	A31RZFBC-MX2.MDR	30x100			

Formato (cm)	Spessore (mm)	Pezzi X	M ² X	Kg X	X Eu. Pallet	M ² X Eu. Pallet	kg X Eu. Pallet
30x100	11	5	1.50	31.25	32	48	1000.00

Loft Brick

SIGNATURE
COLLECTION



Wall: Loft Brick Light Greige 6,5x26 cm,
Loft Brick Light Green Decor 6,5x26cm



Wall: Loft Brick Light Greige 6,5x26 cm,
Loft Brick Light Greige Decor 6,5x26cm

SIGNATURE
COLLECTION

Loft Brick



Wall: Loft Brick White 6,5x26 cm,
Loft Brick Black Decor 6,5x26 cm

Loft Brick



loft brick white



loft brick grey



loft brick black



loft brick warm white



loft brick light greige

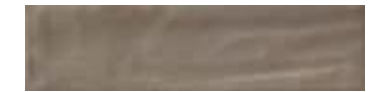

loft brick greige



loft brick white decor
6,5x26 cm

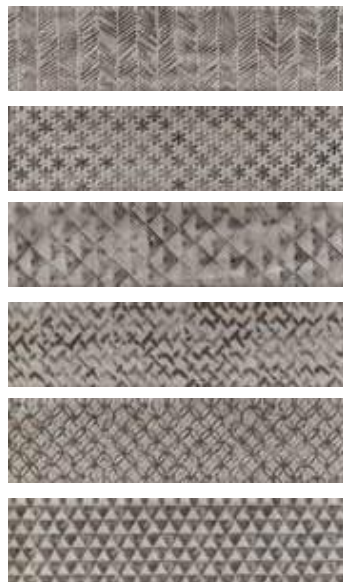

loft brick grey decor
6,5x26 cm



loft brick black decor
6,5x26 cm



loft brick warm white decor
6,5x26 cm

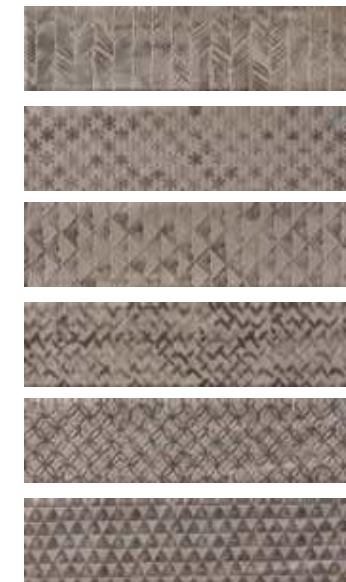

loft brick light greige decor
6,5x26 cm



loft brick greige decor
6,5x26 cm

Formati | Sizes | Formats | Formatos

6,5x26 cm

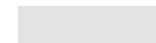

Price Codes

Formato(CM)	Plain	Decor
6,5x26	A4	A7

Loft Brick



loft brick beige



loft brick brown



loft brick beige decor
6.5x26 cm



loft brick brown decor
6.5x26 cm



loft brick yellow

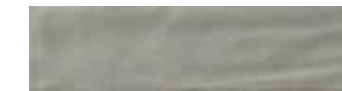

loft brick light green



loft brick yellow decor
6.5x26 cm



loft brick light green decor
6.5x26 cm

Formato (cm)	Spessore (mm)	Pezzi X	M ² X	Kg X	X	M ² X	kg X
		Eu. Pallet	Eu. Pallet	Eu. Pallet	Eu. Pallet	Eu. Pallet	Eu. Pallet
6.5x26	vv	41	0.70	12.50	90	63	1125.00

Nome	Codice	Formato(CM)	Nome	Codice	Formato(CM)
loft brick white	A56WLOBR-WH0.G0U	6.5x26	loft brick white decor	A56WLOBR-WH0.GDU	6.5x26
loft brick light greige	A56WLOBR-LGE.G0U	6.5x26	loft brick light greige decor	A56WLOBR-LGE.GDU	6.5x26
loft brick grey	A56WLOBR-GY0.G0U	6.5x26	loft brick grey decor	A56WLOBR-GY0.GDU	6.5x26
loft brick black	A56WLOBR-BK0.G0U	6.5x26	loft brick black decor	A56WLOBR-BK0.GDU	6.5x26
loft brick warm white	A56WLOBR-WW0.G0U	6.5x26	loft brick warm white decor	A56WLOBR-WW0.GDU	6.5x26
loft brick beige	A56WLOBR-BE0.G0U	6.5x26	loft brick beige decor	A56WLOBR-BE0.GDU	6.5x26
loft brick brown	A56WLOBR-BR0.G0U	6.5x26	loft brick brown decor	A56WLOBR-BR0.GDU	6.5x26
loft brick greige	A56WLOBR-GE0.G0U	6.5x26	loft brick greige decor	A56WLOBR-GE0.GDU	6.5x26
loft brick light green	A56WLOBR-LV0.G0U	6.5x26	loft brick light green decor	A56WLOBR-LV0.GDU	6.5x26
loft brick yellow	A56WLOBR-YE0.G0U	6.5x26	loft brick yellow decor	A56WLOBR-YE0.GDU	6.5x26

Mare

SIGNATURE
COLLECTION

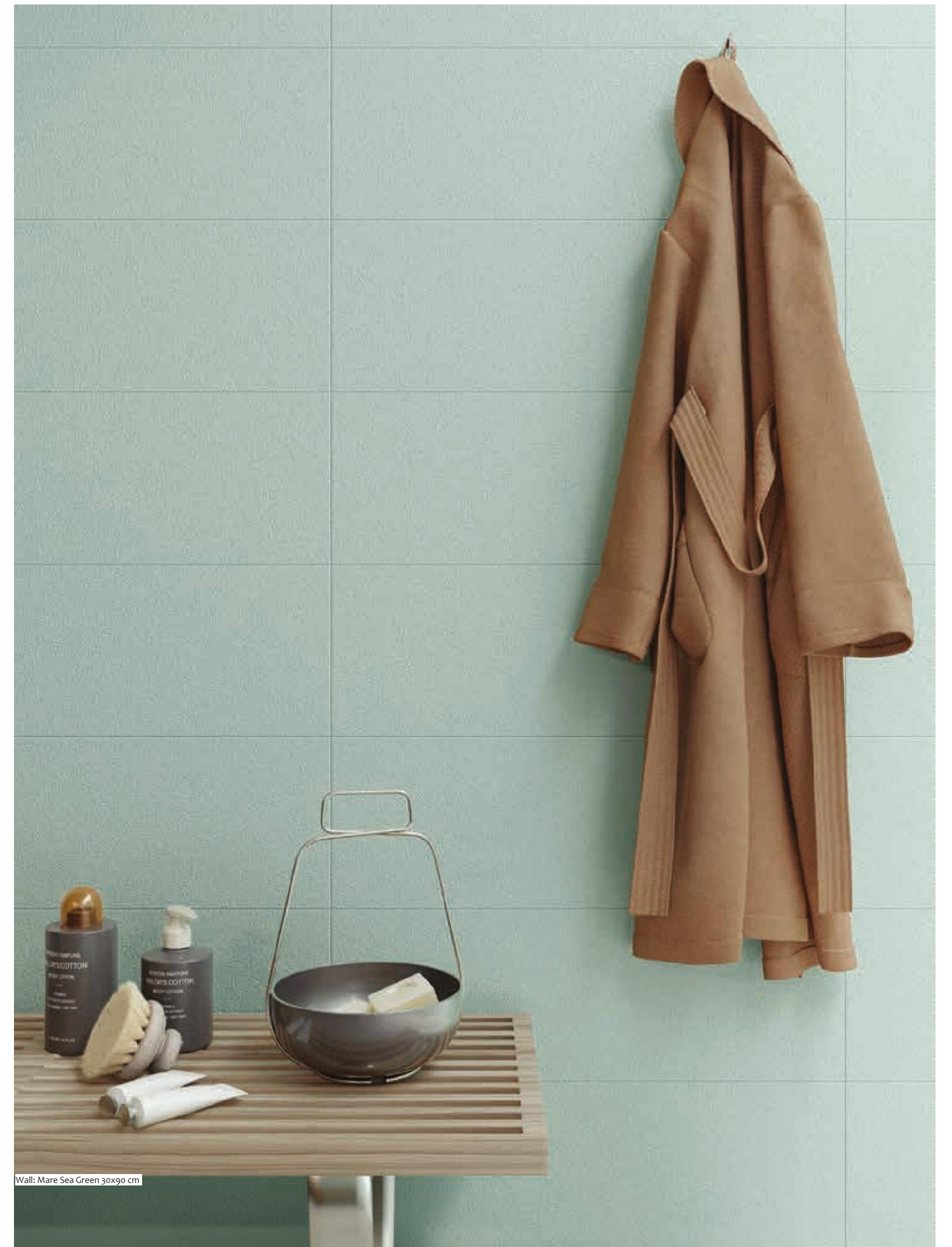
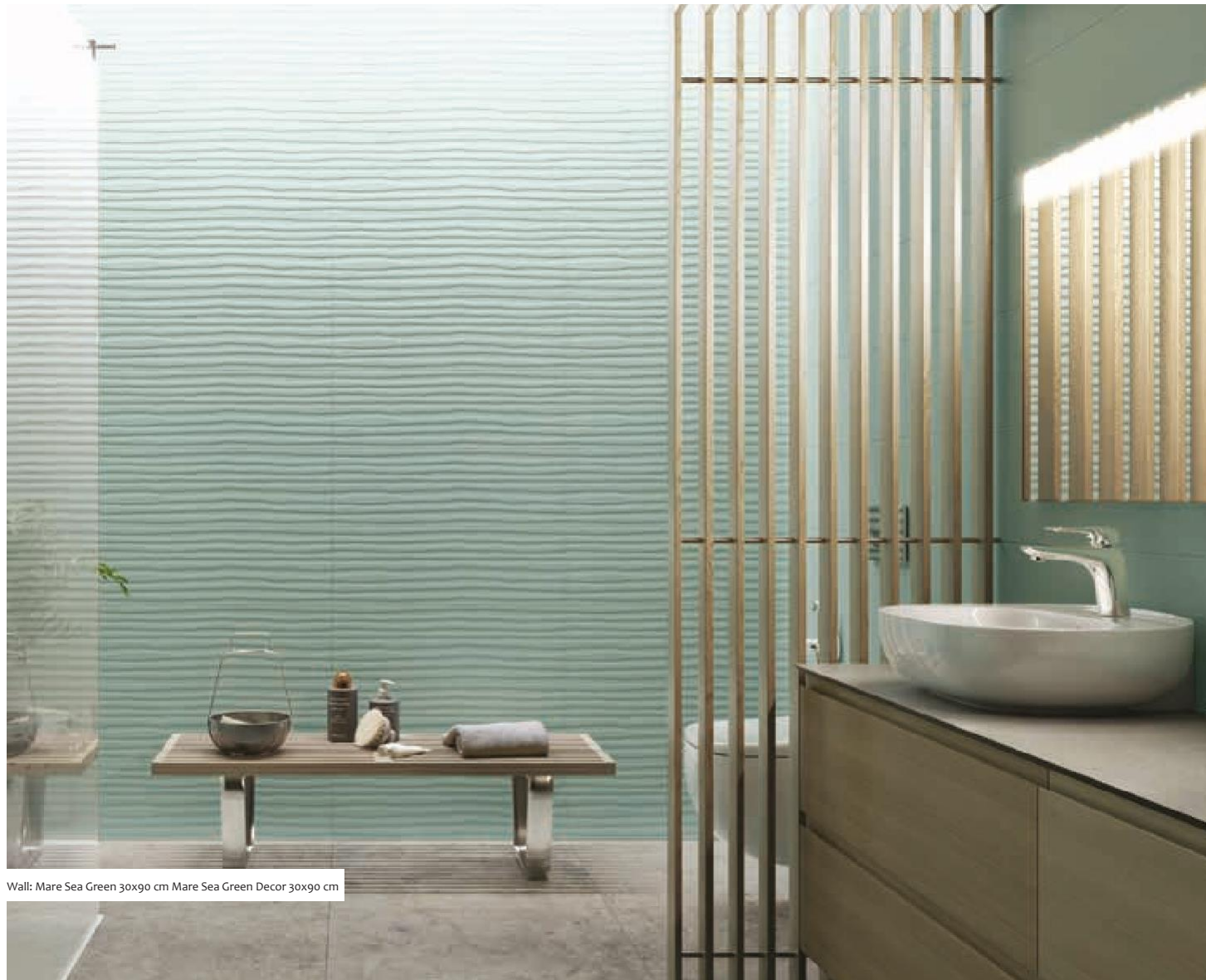

SIGNATURE
COLLECTION

Mare

Wall: Mare Light Blue 30x90 cm, Mare Light Blue Decor 30x90 cm

Mare

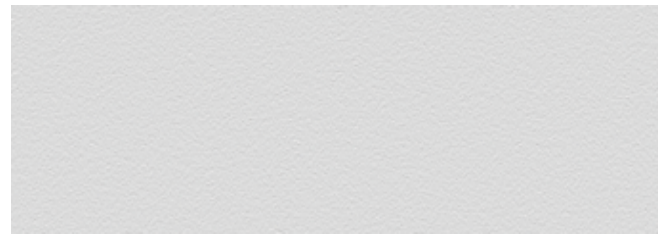

mare off white

LS



mare sea green

LS



mare light blue

LS



mare beige

LS



mare rose

LS

Formati | Sizes | Formats | Formatos

30x90 cm

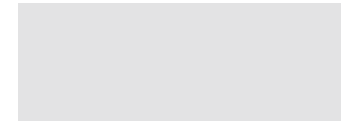

Price Codes

Formato(CM)	Plain	Decor
30x90	A3	A6

Nome	Codice	Formato(CM)
mare off white	A39RMARE-OWH.M6XoR	30x90
mare light blue	A39RMARE-LIB.M6XoR	30x90
mare beige	A39RMARE-BEE.M6XoR	30x90
mare rose	A39RMARE-RSE.M6XoR	30x90
mare sea green	A39RMARE-SEG.M6XoR	30x90
mare off white decor	A39RMARE-OWH.MWXoR	30x90
mare light blue decor	A39RMARE-LIB.MWXoR	30x90
mare beige decor	A39RMARE-BEE.MWXoR	30x90
mare rose decor	A39RMARE-RSE.MWXoR	30x90
mare sea green decor	A39RMARE-SEG.MWXoR	30x90

Formato (cm)	Spessore (mm)	Pezzi X	M² X	Kg X	X Eu. Pallet	M² X Eu. Pallet	Kg X Eu. Pallet
30x90	9.5	7	1.89	35.00	32	-	1120.00

Mare



mare off white decor
30x90 cm

HS



mare sea green decor
30x90 cm

HS



mare light blue decor
30x90 cm

HS



mare beige decor
30x90 cm

HS

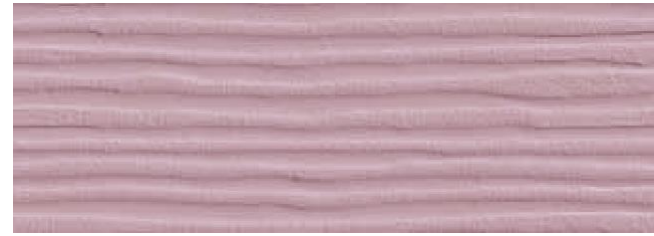

mare rose decor
30x90 cm

HS



Wall: Mare Rose 30x90 cm,
Mare Rose Decor 30x90 cm

Ripple



Wall: Ripple White 25x90 cm, Ripple White Decor 25x90 cm

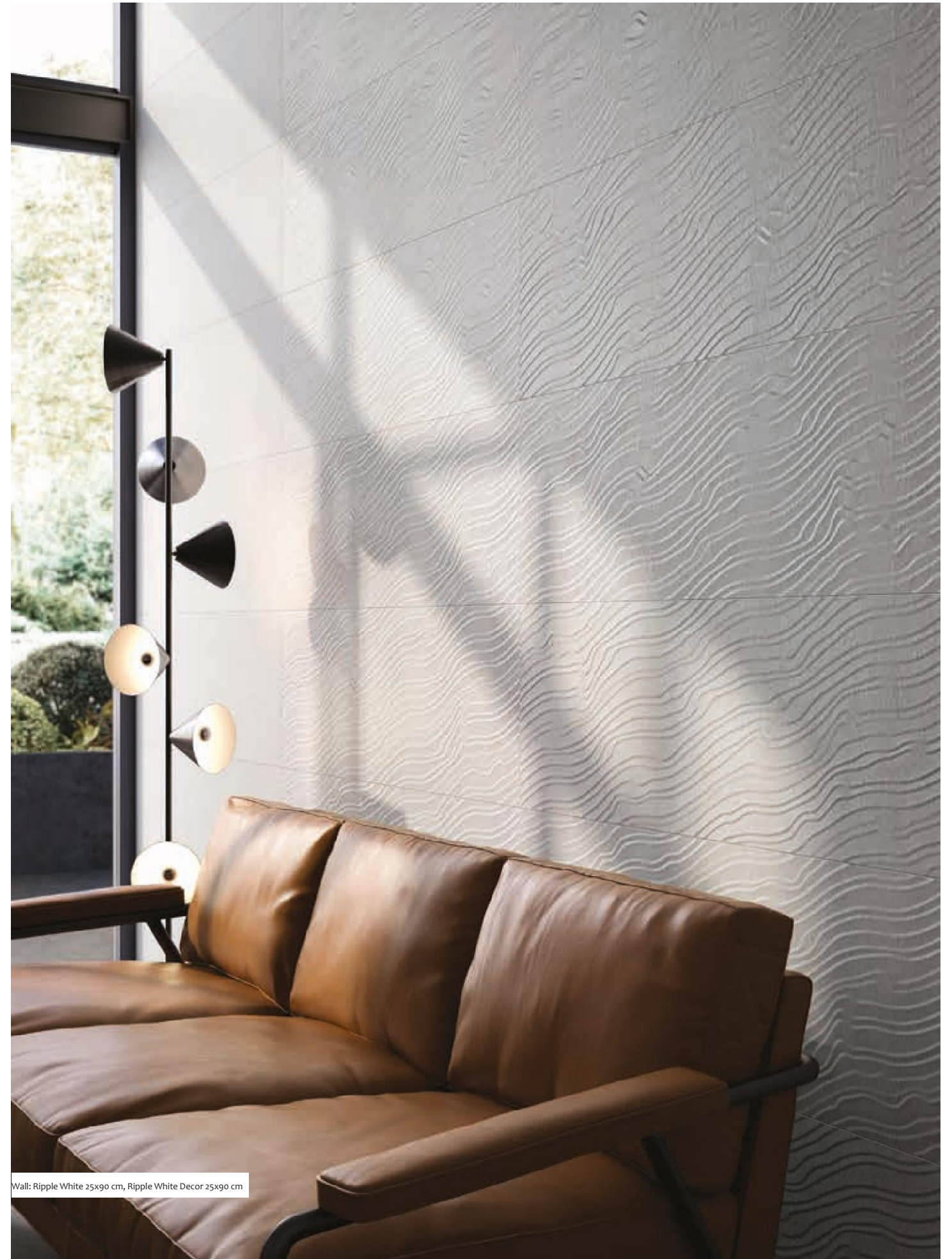

Wall: Ripple White 25x90 cm, Ripple White Decor 25x90 cm



Ripple

Wall: Ripple White 25x90 cm, Ripple White Decor 25x90 cm

Ripple



ripple snow



ripple slate grey

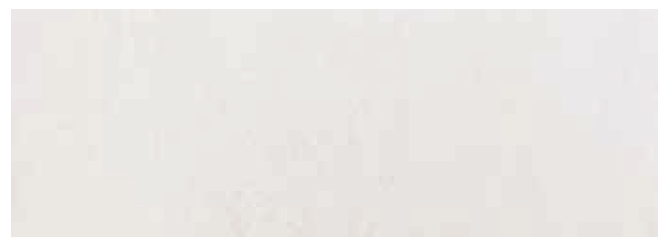

ripple ivory



ripple burly wood



ripple snow decor

HS

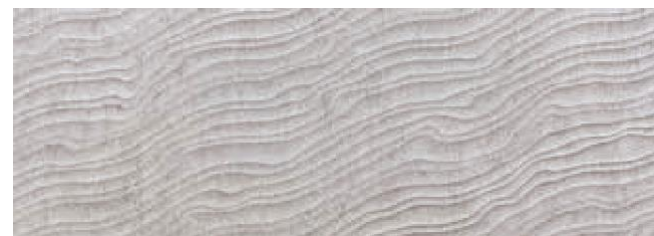

ripple slate grey decor

HS



ripple ivory decor

HS



ripple burly wood decor

HS

Formati | Sizes | Formats | Formatos

25x90 cm

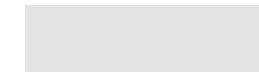

Price Codes

Formato(CM)	Plain	Decor
25x90	A3	A6

Nome	Codice	Formato(CM)
ripple snow	ARB43ZRPLSNWZMSNLR	25x90
ripple slate grey	ARB43ZRPLSLAZMSNLR	25x90
ripple ivory	ARB43ZRPLIVOZMSNLR	25x90
ripple burly wood	ARB43ZRPLBUWZMSNLR	25x90
ripple snow decor	ARD45ZRPLSNWZMHW3R	25x90
ripple slate grey decor	ARD43ZRPLSLAZMHW3R	25x90
ripple ivory decor	ARD45ZRPLIVOZMHW3R	25x90
ripple burly wood decor	ARD43ZRPLBUWZMHW3R	25x90

Formato (cm)	Spessore (mm)	Pezzi X	M' X	Kg X	Eu. Pallet	M' X Eu. Pallet	kg X Eu. Pallet
25x90	10.5	8	1.80	35.00	24	43.20	840.00

Sensation White

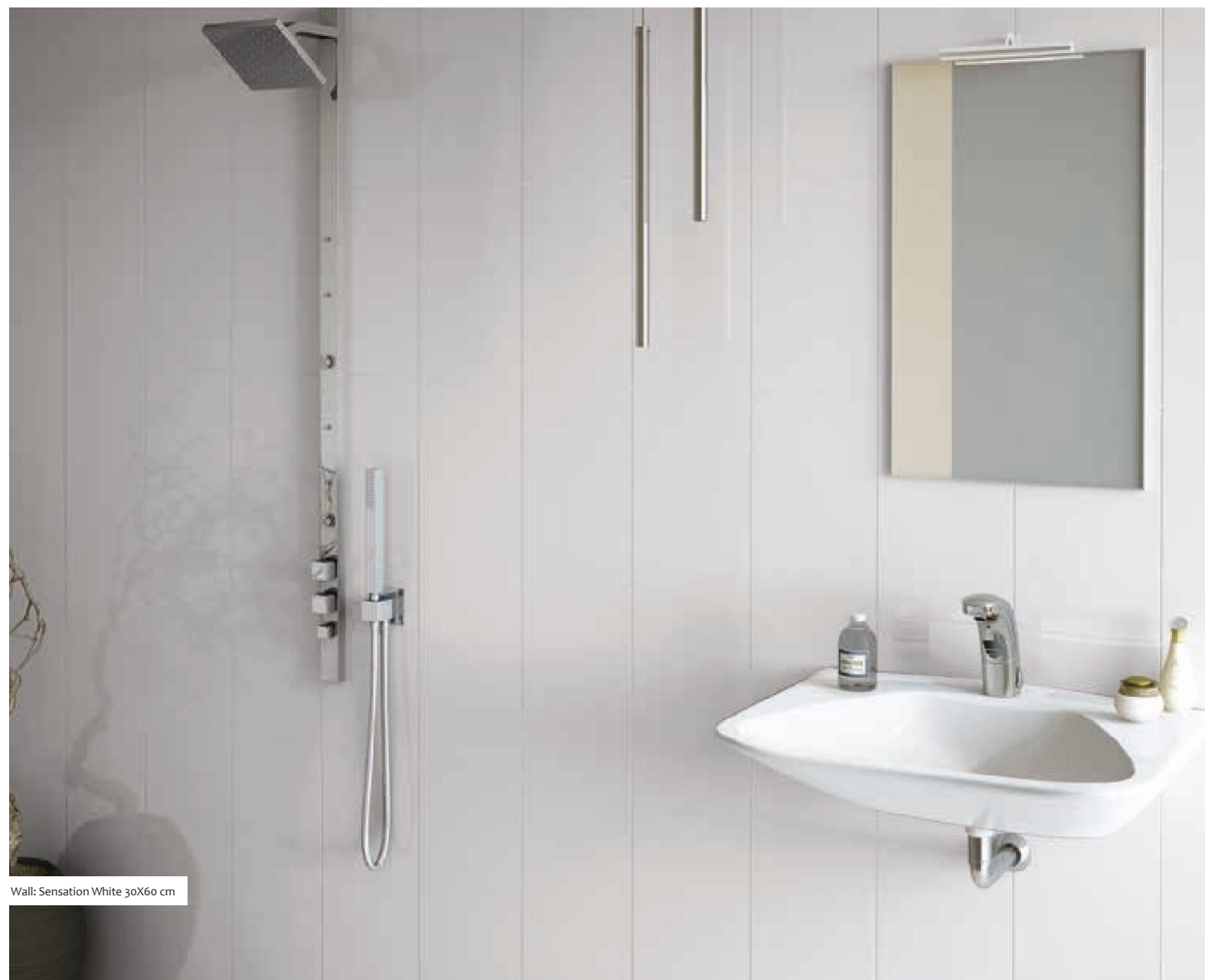

Wall: Sensation White 30X60 cm

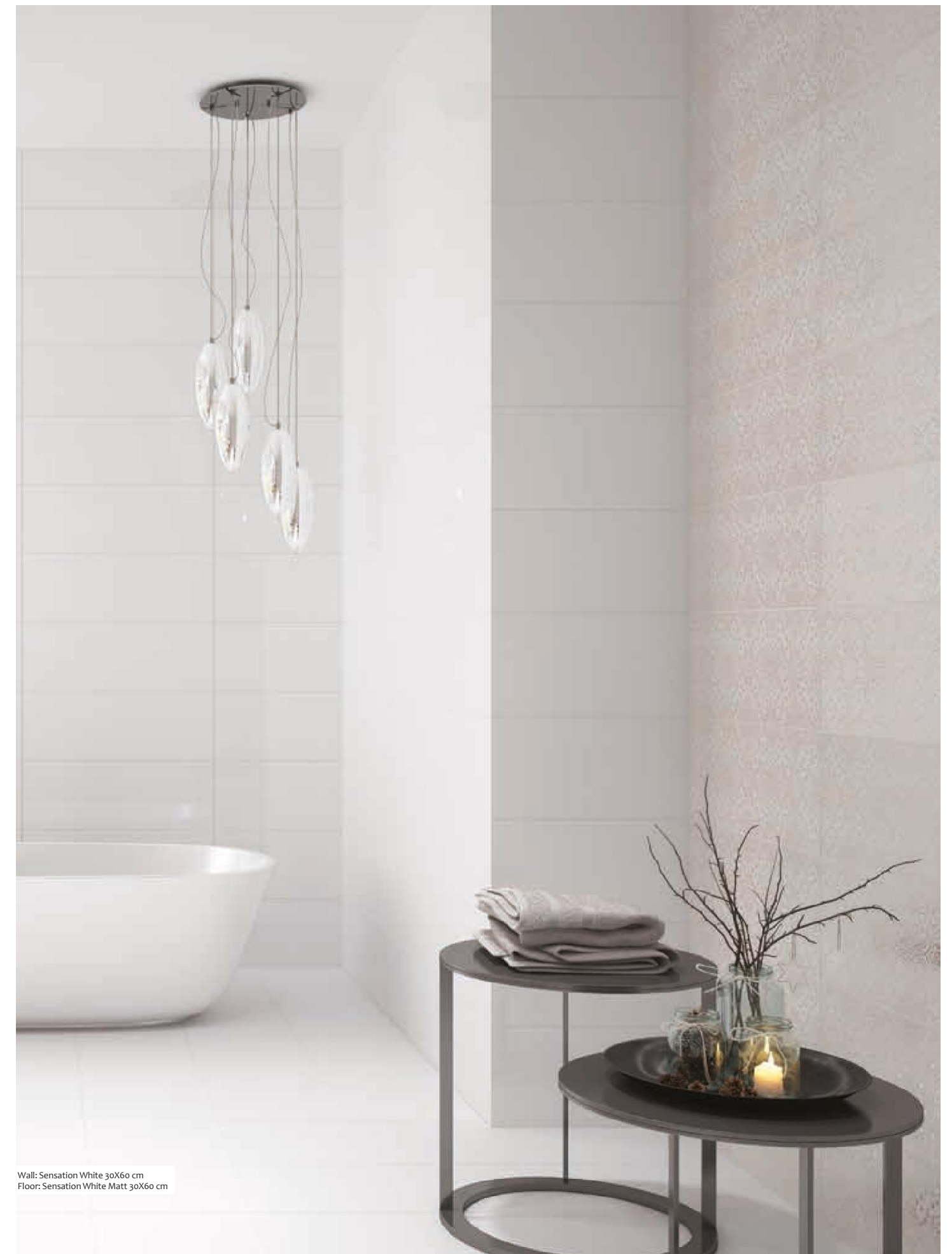

Wall: Sensation White 30X60 cm
Floor: Sensation White Matt 30X60 cm

Sensation White



Wall: Sensation White 30X60 cm
Floor: Sensation White Matt 30X60 cm

Sensation White

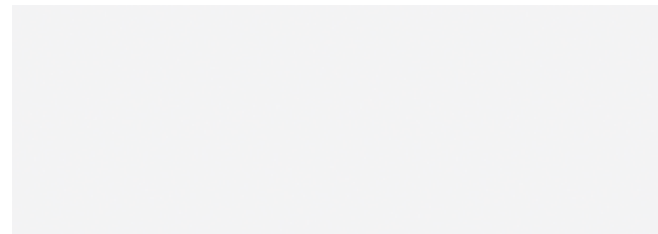
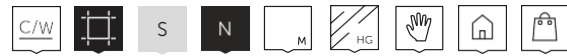

sensation white matt

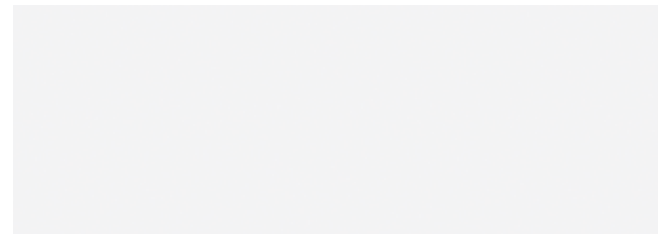

sensation white glossy

Formati | Sizes | Formats | Formatos

30x60 cm

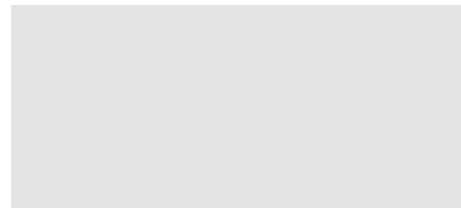

Price Codes

Formato(CM)	Matt	Glossy
30x60	A3	A3



Wall: Sensation White 30X60 cm
Floor: Sensation White Matt 30X60 cm

Nome	Codice (Matt)	Formato(CM)	Codice (Glossy)	Formato(CM)
sensation white	A14WSUPR-WHo.MoS4R/DKS	30x60	A14WSUPR-WHo.HoS4R/DKS	30x60

Formato (cm)	Spessore (mm)	Pezzi X	M ² X	Kg X	X Eu. Pallet	M ² X Eu. Pallet	kg X Eu. Pallet
30x60	8	8	1.44	20.52	40	57.6	820.8

Spatula

SIGNATURE
COLLECTION

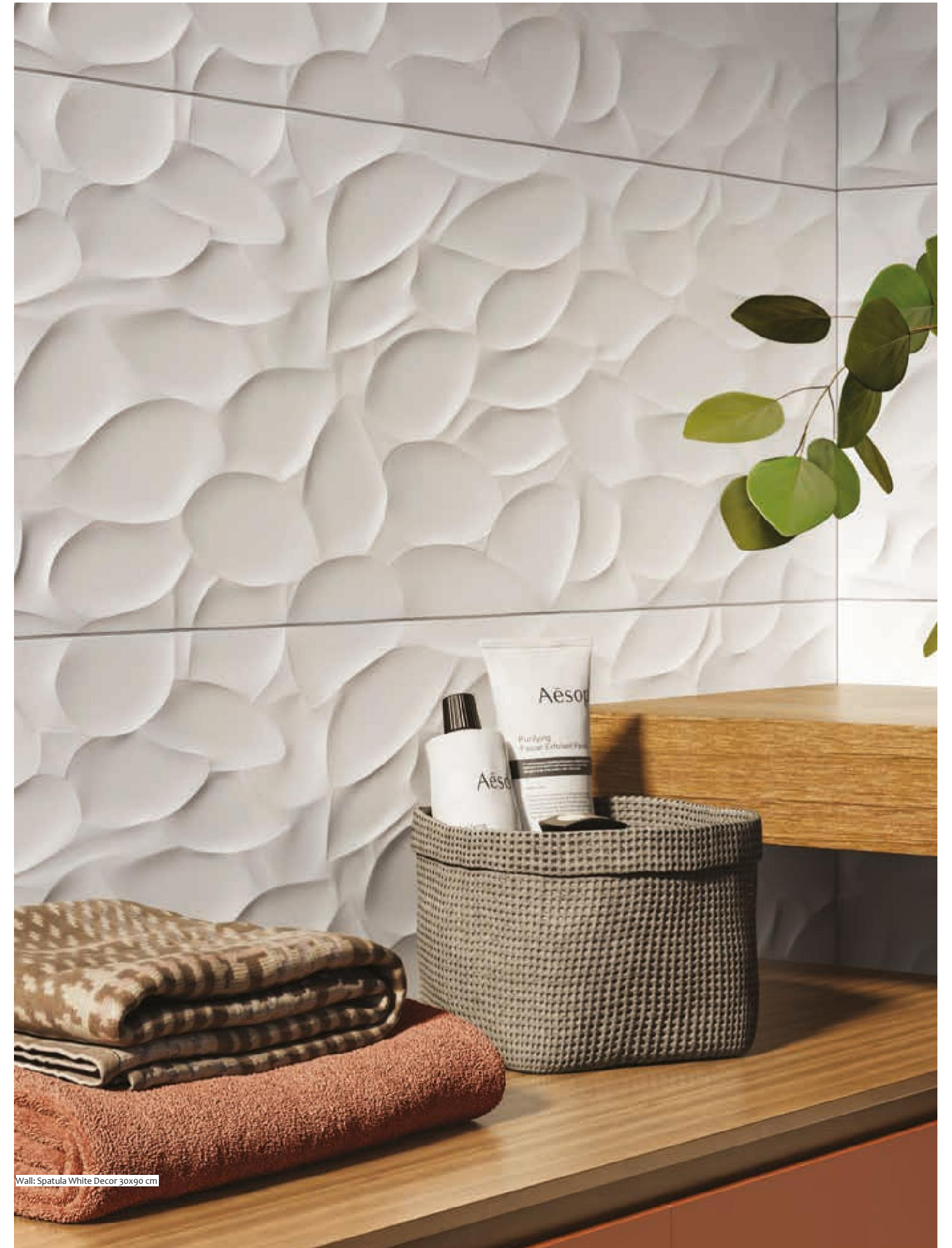

SIGNATURE
COLLECTION

Spatula

Wall: Spatula Terra Cotta 30x90 cm,
Spatula White Decor 30x90 cm

Spatula



spatula white

LS



spatula beige

LS



spatula turquoise

LS

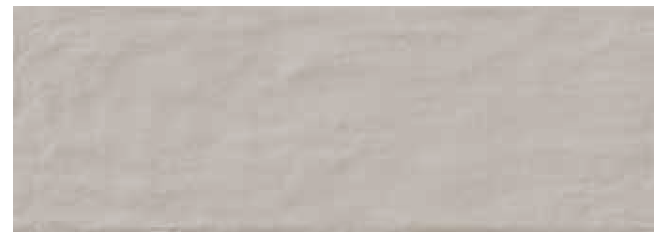

spatula tortora

LS



spatula denim blue

LS



spatula terra cotta

LS

Formati | Sizes | Formats | Formatos

30x90 cm

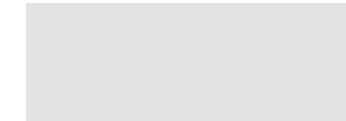

Price Codes

Formato(CM)	Plain	Decor
30x90	A3	A6

Nome	Codice	Formato(CM)
spatula white	A39RSPTL-WHE.M6XoR	30x90
spatula beige	A39RSPTL-BEE.M6XoR	30x90
spatula tortora	A39RSPTL-TOR.M6XoR	30x90
spatula terracotta	A39RSPTL-TCO.M6XoR	30x90
spatula denim blue	A39RSPTL-DMB.M6XoR	30x90
spatula turquoise	A39RSPTL-TQS.M6XoR	30x90
spatula white decor	A39RSPTL-WHE.MJXoR	30x90
spatula beige decor	A39RSPTL-BEE.MJXoR	30x90
spatula tortora decor	A39RSPTL-TOR.MJXoR	30x90
spatula terracotta decor	A39RSPTL-TCO.MJXoR	30x90
spatula denim blue decor	A39RSPTL-DMB.MJXoR	30x90
spatula turquoise decor	A39RSPTL-TQS.MJXoR	30x90

Formato (cm)	Spessore (mm)	Pezzi X	M ² X	Kg X	X Eu. Pallet	M ² X Eu. Pallet	kg X Eu. Pallet
30x90	9.5	7	1.89	35.00	32	-	1120.00

Spatula



spatula white decor
30X90 cm

HS



spatula beige decor
30X90 cm

HS



spatula turquoise decor
30X90 cm

HS



spatula tortora decor
30X90 cm

HS



decor denim blue decor
30X90 cm

HS



spatula terra cotta decor
30X90 cm

HS



Wall: Spatula Beige Decor 30x90 cm

Taut

SIGNATURE
COLLECTION



SIGNATURE
COLLECTION

Taut



Wall: Taut White 40x120 cm, Taut Salvia 40x120 cm,
Taut Tortora Mix Decor 40x120 cm
Floor: Taut Salvia 40x120 cm

Taut



taut white LS



taut beige LS



taut tortora LS



taut grey LS



taut brown grey LS



taut blue LS



taut salvia LS

Formati | Sizes | Formats | Formatos

40x120 cm

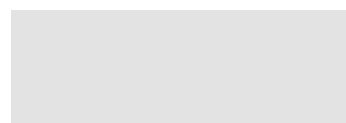

taut tortora mix decor
40x120 cm



HS

Price Codes

Formato(CM)	Plain	Decor
40x120	A6	A11

Nome	Codice	Formato(CM)
taut white	ARB45TAUTWHEZMLNLR	40x120
taut beige	ARB45TAUTBEEZMLNLR	40x120
taut tortora	ARB45TAUTORZMLNLR	40x120
taut grey	ARB45TAUTGRYZMLNLR	40x120
taut brown grey	ARB45TAUTBGYZMLNLR	40x120
taut blue	ARB45TAUTBLEZMLNLR	40x120
taut salvia	ARB45TAUTSLVZMLNLR	40x120
taut mix decor	ARD45TAUTMSzZMHN1R	40x120

Formato (cm)	Spessore (mm)	Pezzi X	M ² X	Kg X	X Eu. Pallet	M ² X Eu. Pallet	Kg X Eu. Pallet
40x120	10	4	1.92	35.00	28.00	53.76	980.00

Wels

SIGNATURE
COLLECTION



Wall: Wels White Line Decor 30x100 cm,
Wels White Leaf Decor 30x100 cm



Wall: Wels White Line Decor 30x100 cm,
Wels White Leaf Decor 30x100 cm

SIGNATURE
COLLECTION

Wels

Wall: Wels White Line Decor 30x100 cm,
Wels White Leaf Decor 30x100 cm

Wels



wels white



wels white line decor



wels white dotted line decor



wels white damasco decor



wels white wave decor



wels white leaf decor

HS

Sizes | Formati | Formatos

30X100 cm

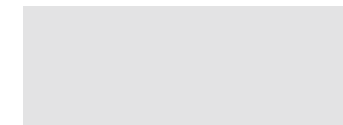

Price Codes

Formato(CM)	Plain	Decor
30x100	A3	A6

Nome	Codice	Formato(CM)
wels white	A31RZWEL-WH0.MoR	30x100
wels white line decor	A31RZWEL-WH5.MoR	30x100
wels white dotted line decor	A31RZWEL-WH2.MoR	30x100
wels white damasco decor	A31RZWEL-WH1.MoR	30x100
wels white wave decor	A31RZWEL-WH4.MoR	30x100
wels white leaf decor	A31RZWEL-WH3.MoR	30x100

Formato (cm)	Spessore (mm)	Pezzi X	M ² X	Kg X	X Eu. Pallet	M ² X Eu. Pallet	kg X Eu. Pallet
30x100	11	5	1.50	31.25	32	48	1000.00

Product Guide

Product Guide
Guide Au Produit
Guía Del Producto

CARATTERISTICHE TECNICHE

TECHNICAL FEATURES | CARACTÉRISTIQUES TECHNIQUES |
CARACTERÍSTICAS TÉCNICAS

GRES PORCELLANATO (Bla - GL) :

Le piastrelle in gres porcellanato vengono prodotte utilizzando materie prime d'importazione pure e selezionate, miscelate utilizzando le tecniche di estrazione e selezione più avanzate; esse sono prodotte inoltre con un processo simile a quello utilizzato per le piastrelle in monocottura.

Le materie prime vengono sottoposte ad un processo di macinazione ad umido, seguito da essiccazione a spruzzo parziale, stoccaggio in silos per consentirne l'omogeneizzazione, quindi la miscela viene pressata mediante presse idrauliche ad alta efficienza fino a pressioni specifiche superiori a 500 kg/cm². L'alta pressione, insieme all'alta temperatura di cottura, superiore ai 1200°C, produce una superficie ceramica molto compatta e resistente, con un rapporto di assorbimento dell'acqua molto basso (inferiore allo 0,1%, conformemente allo standard UNI EN ISO 10545-3) e una resistenza meccanica estremamente alta (valore medio superiore a 50 N/mm², conformemente allo standard UNI EN ISO 10545-4).

Grazie alla loro bassa porosità, queste piastrelle sono a prova di congelamento e classificate nel gruppo Bla GL in base allo standard europeo UNI EN 14411, che richiede un livello di assorbimento dell'acqua ≤ 0,5%.

Il modulo di rottura (MoR), conforme allo standard UNI EN ISO 10545-4, è di 50 N/mm², contro un requisito minimo di 35 N/mm². Le piastrelle porcellanate della RAK Ceramics sono disponibili in un'ampia gamma di forme, dimensioni e finiture.

CONSIGLI PER LA POSA

Anche se le nostre piastrelle di gres porcellanato possono essere posate mediante malte cementizie tradizionali, consigliamo gli adesivi moderni. Quando si posa su parete, si raccomanda il sistema di spargimento a due strati per bagnare perfettamente il retro della piastrella. Immergere rapidamente in acqua ciascuna piastrella prima della posa servirà a rimuovere la polvere dal retro della piastrella al fine di una perfetta adesione; tuttavia, non bagnare le piastrelle quando si usano adesivi a base di resine acriliche o viniliche o adesivi a base di solventi organici a due componenti.

Quando si posa su pavimenti di ampie dimensioni è consigliabile incorporare idonei giunti di ritiro-flessione (giunti di movimento/espansione) che non devono essere distanziati più di 4-5 metri l'uno dall'altro negli ambienti interni o 3 metri lineari negli ambienti esterni. Prestare attenzione quando si usano stucchi molto colorati, poiché potrebbero lasciare sulla superficie delle piastrelle macchie che potrebbero risultare difficili da rimuovere in seguito.



PORCELAIN TILES (Bla - GL) :

Porcelain tiles are manufactured using pure, selectively imported raw materials mixed using the most advanced extraction and sorting techniques; they are obtained with a production process similar to that of single-fired tiles.

The resulting product is top-quality porcelain tile, obtained by raw materials wet grinding, followed by partial drying by spraying, silo storage to allow homogenization of properties, and pressing with highly efficient hydraulic presses up to specific pressures more than 500 kg/cm². The high pressure combined with high firing temperature exceeding 1200 °C results in highly compact & strong ceramic surface with very low water absorption (lower than 0.1% according to UNI EN ISO 10545-3) and extremely high mechanical resistance (average value exceeding 50 N/mm² according to UNI EN ISO 10545-4).

Thanks to their low porosity, these porcelain tiles are frost-proof and rated as belonging to the Bla GL class according to the European Standard UNI EN 14411 which requires water absorption ≤ 0.5%.

The MoR (modulus of rupture) in accordance with UNI EN ISO 10545-4 results to 50 N/mm² while the required value is 35 N/mm². RAK Ceramics porcelain tiles are available in a wide range of designs, sizes and finishes.

ADVICE ON LAYING

Although our porcelain tiles can be installed using traditional cement mortars, we advise using modern adhesives. While installing on wall, the two-layer spreading system is recommended to perfectly wet the back of the tile.

Quickly dipping each tile in water before installation will remove any dust on the back of the tile for perfect adhesion. Do not wet the tiles if you are using vinyl, acrylic resin adhesives or two-component organic-solvent based adhesive.

It is advisable to incorporate suitable shrinkage - flexion joints (movement/ expansion joints) when installing on large floors: the joints should never be spaced more than 4 - 5 linear meters apart indoors and 3 linear meters apart outdoors. Be careful while using strong coloured grouts as they might leave stains on the surface of the tiles that may be difficult to remove later.



CARREAUX EN GRÈS CÉRAME (BIA - GL):

Les carreaux en grès cérame sont fabriqués à partir de matières premières pures sélectivement importées, mélangées à l'aide des techniques d'extraction et de tri des plus sophistiquées ; et leur fabrication nécessite un processus de production identique à celui des carreaux en monocuisson.

Les matières premières entament un processus de broyage humide suivi du séchage partiel par pulvérisation, du silotage pour assurer l'homogénéisation, puis le mélange est pressé grâce à des presses hydrauliques haute efficacité à une puissance de pressage spécifique de plus de 500 kg/cm². Combinée à une température de cuisson élevée excédant 1200°C, la forte pression entraîne une surface céramique très compacte et solide à faible taux d'absorption d'eau (inférieure à 0,1% selon la norme UNI EN ISO 10545-3) et d'une résistance mécanique extrêmement élevée (valeur moyenne dépassant 50 N/mm² selon la norme UNI EN ISO 10545-4).

Grâce à leur faible porosité, ces carreaux en grès cérame émaillés résistent au gel et sont classés dans le groupe Bla GL conformément à la norme européenne UNI EN 14411 exigeant un taux d'absorption d'eau ≤ 0,5%.

Le module de rupture (MoR) conformément à la norme UNI EN ISO 10545-4 est de 50 N/mm², alors que la valeur requise est de 35 N/mm². Les carreaux en grès cérame émaillés de RAK Ceramics sont disponibles dans un large éventail de modèles, tailles et finitions.

RECOMMANDATIONS EN MATIÈRE DE POSE

Bien que nos carreaux en grès de cérame peuvent être posés à l'aide de mortiers de ciment traditionnels, nous recommandons l'utilisation de colles modernes. Lors de la pose sur des murs, le système d'épandage bi-couches est recommandé pour bien humidifier l'envers du carreau.

Pour une meilleure adhésion, il est possible de plonger de manière rapide chaque carreau dans l'eau avant la pose. Cependant, évitez de mouiller les carreaux en cas d'utilisation de colles à base de résine acrylique ou vinylique ou en cas d'utilisation de colle à base de solvant organique bi-composants.

Il est recommandé d'utiliser des joints de retrait-flexion (joints de mouvement/dilatation) lors de la pose sur des grandes surfaces : les joints ne doivent jamais être espacés l'un de l'autre de plus de 4 à 5 mètres linéaires à l'intérieur et de 3 mètres linéaires à l'extérieur. Faites preuve de prudence en cas d'utilisation de coulis colorés solides, lesquels peuvent laisser, sur la surface des carreaux, des taches qui peuvent être difficiles à éliminer plus tard.



PORCELÁNICO (BIA - GL) :

Los azulejos de porcelánico son elaborados utilizando material prima pura, importada selectivamente, mezclada utilizando las técnicas de extracción y clasificación más avanzadas; y son fabricados utilizando un proceso similar al utilizado con azulejos de cocción simple.

La materia prima pasa por un proceso de amolado húmedo, seguido por secado parcial con rociador, almacenamiento en silos para permitir la homogenización, y después la mezcla es prensada utilizando prensas hidráulicas de alta eficacia, que los lleva a presiones específicas de más de 500 kg/cm². La alta presión combinada con una temperatura de cocción de más de 1200 °C resulta en una superficie cerámica altamente compacta y fuerte con poca absorción de agua (menor a 0.1% de acuerdo a la norma UNI EN ISO 10545-3) y resistencia mecánica extremadamente alta (el valor promedio sobrepasando 50 N/mm² de acuerdo a la norma UNI EN ISO 10545-4).

Gracias a su baja porosidad, estos azulejos de porcelánico son a prueba de escarcha y calificados como pertenecientes a la clase Bla GL de acuerdo a la norma europea UNI EN 14411 la cual requiere absorción de agua ≤ 0.5%.

El módulo de ruptura (MoR) de acuerdo con UNI EN ISO 10545-4 es 50 N/mm² mientras el valor requerido es de 35 N/mm². Los azulejos de porcelánico esmaltado de RAK Ceramics están disponibles en una ancha gama de diseños, tamaños y acabados.









SUGERENCIAS PARA SU COLOCACION







Aunque nuestros azulejos de porcelánico pueden ser instalados utilizando morteros de cemento tradicionales, sugerimos utilizar adhesivos modernos. Al instalarlo en paredes, se recomienda el sistema de distribución de dos capas para humedecer perfectamente la parte posterior del azulejo.

El bañar rápidamente cada azulejo en agua antes de la instalación eliminará cualquier cantidad de polvo de la parte trasera del azulejo para una adhesión perfecta; sin embargo, no moje los azulejos si está utilizando vinil, adhesivos de resina de acrílico o adhesivo con base de solvente orgánico de dos componentes.

Se recomienda siempre incorporar juntas de dilatación -contracción (juntas de movimiento y expansión) apropiadas al instalar sobre pisos extensos: las juntas nunca deben ser colocadas a más de 4 o 5 metros lineales de espacio entre ellas en el interior, y 3 metros lineales de espacio entre ellas en el exterior. Tenga cuidado al utilizar lechada de color ya que pueden dejar manchas sobre la superficie de los azulejos que pueden ser difíciles de eliminar después.

CARATTERISTICHE TECNICHE - GRES PORCELLANATO (BIA - GL)
TECHNICAL CHARACTERISTICS - PORCELAIN TILES (BIA - GL)
CARACTÉRISTIQUES TECHNIQUES - GRÈS CÉRAME (BIA - GL)
CARACTERÍSTICAS TÉCNICAS - GRES PORCELÁNICO (BIA - GL)

Descrizione del testo Test Description Description d'essai Descripción de la Prueba	Metodo di prova Standard Test Method Méthode d'essai standard Método de Prueba Estándar	Requisiti previsti dalla norma ISO 13006 International Standard ISO 13006 Norme internationale ISO 13006 Norma Internacional ISO 13006	RAK Ceramics - Specifiche RAK Ceramics Specifications Spécifications RAK Ceramics RAK Ceramics Especificaciones	
			(Rettificato) (Rectified) (Rectifié) (Rectificado)	(Non rettificato) (Unrectified) (Non rectifié) (No rectificado)
 Lunghezza larghezza Length & Width Longueur & Largeur Longitud y Ancho	BS EN ISO 10545-2	+/- 0.6%	+/- 0.1%	+/- 0.3%
 Spessore Thickness Épaisseur Grosor	BS EN ISO 10545-2	+/- 5.0%	+/- 5.0%	+/- 5.0%
 Ortogonalità rettangolare Rectangle Squareness Rectangulaire Équerrage Cuadratura Rectangular	BS EN ISO 10545-2	+/- 0.6%	+/- 0.2%	+/- 0.4%
 Rettilineità dei lati Straightness of sides Rectitude des côtés Rectitud de los lados	BS EN ISO 10545-2	+/- 0.5%	+/- 0.2%	+/- 0.3%
 Planarità della superficie Surface Flatness Planéité de surface Horizontalidad de la Superficie	BS EN ISO 10545-2	+/- 0.5%	+/- 0.3%	+/- 0.3%
 Assorbimento dell'acqua Water Absorption Absorption d'eau Absorción de Agua	BS EN ISO 10545-3	<=0.5%	<=0.4%	<=0.4%
 Modulo di Rottura Modulus of Rupture Module de rupture Módulo de Rotura	BS EN ISO 10545-4	>=35 N/mm2	>=40 N/mm2	>=40 N/mm2
 Resistenza alla rottura Breaking Strength Résistance à la rupture Resistencia de Rotura	BS EN ISO 10545-4	>=1300N	>=1500N	>=1600N
 Resistenza all'abrasione superficiale Resistance to surface abrasion Résistance à l'abrasion de surface Resistencia a la Abrasión Superficial	BS EN ISO 10545-6	Classe di abrasione indicata dal produttore Manufacturer to state Abrasion Class Le fabricant doit indiquer la classe d'abrasion Fabricado según el tipo de abrasión especificado	PEI Classe 2-5 PEI Class 2-5 PEI Classe 2-5 PEI Classe 2-5	PEI Classe 2-5 PEI Class 2-5 PEI Classe 2-5 PEI Classe 2-5

Descrizione del testo Test Description Description d'essai Descripción de la Prueba	Metodo di prova Standard Test Method Méthode d'essai standard Método de Prueba Estándar	Requisiti previsti dalla norma ISO 13006 International Standard ISO 13006 Norme internationale ISO 13006 Norma Internacional ISO 13006	RAK Ceramics - Specifiche RAK Ceramics Specifications Spécifications RAK Ceramics RAK Ceramics Especificaciones		
			(Rettificato) (Rectified) (Rectifié) (Rectificado)	(Non rettificato) (Unrectified) (Non rectifié) (No rectificado)	(Non rettificato) (Unrectified) (Non rectifié) (No rectificado)
 Dilatazione termica lineare Linear Thermal Expansion Dilatation thermique linéaire Expansión Térmica Lineal	BS EN ISO 10545-8	<=9x10 ⁻⁶ /C ⁴	<=7x10 ⁻⁶ /C ⁴	<=7x10 ⁻⁶ /C ⁴	
 Resistenza agli shock termici Resistance to Thermal Shock Résistance aux chocs thermiques Resistencia al Choque Térmico	BS EN ISO 10545-9	Nessun effetto visibile No visible effect Aucun effet visible Sin efecto visibles	Nessun effetto visibile No visible effect Aucun effet visible Sin efecto visibles	Nessun effetto visibile No visible effect Aucun effet visible Sin efecto visibles	
 Resistenza alla screpolatura Crazing Resistance Résistance aux craquelures superficielles Resistencia al Agrietamiento	BS EN ISO 10545-11	Nessuna screpolatura No crazing Aucune craquelure Sin agrietamiento	Nessuna screpolatura No crazing Aucune craquelure Sin agrietamiento	Nessuna screpolatura No crazing Aucune craquelure Sin agrietamiento	
 Resistenza al gelo Frost Resistance Résistance au gel Resistencia a la Congelación	BS EN ISO 10545-12	Nessun danno visibile No visible damage Aucun dommage visible Sin daños visibles	Nessun danno visibile No visible damage Aucun dommage visible Sin daños visibles	Nessun danno visibile No visible damage Aucun dommage visible Sin daños visibles	
 Resistenza agli agenti chimici Resistance to chemicals Résistance aux produits chimiques Resistencia a los productos químicos	BS EN ISO 10545-13	Nessun effetto visibile No visible effect Aucun effet visible Sin efecto visibles	Nessun effetto visibile No visible effect Aucun effet visible Sin efecto visibles	Nessun effetto visibile No visible effect Aucun effet visible Sin efecto visibles	
 Resistenza alle macchie Resistance to stains Résistance aux taches Resistencia a las Manchas	BS EN ISO 10545-14	Classe di abrasione Manufacturer to state class Le fabricant doit indiquer la classe Fabricado según lo especificado	Rimozione delle macchie, classe 4 Stain removed Min. class 4 Elimination des taches Min. classe 4 Min. remoción de manchas. Classe 4	Rimozione delle macchie, classe 4 Stain removed Min. class 4 Elimination des taches Min. classe 4 Min. remoción de manchas. Classe 4	
 Resistenza dei colori alla luce UV Colour Resistance to UV Light Résistance des couleurs à la lumière UV Resistencia del Color a la luz UV	DIN 51094	Nessun cambiamento di colore No change in color Pas de changement de couleur Sin cambio de color	Nessun cambiamento di colore No change in color Pas de changement de couleur Sin cambio de color	Nessun cambiamento di colore No change in color Pas de changement de couleur Sin cambio de color	

Note: Shade variation across the batches is inherent to the manufacturing process and the pre-laying colour comparison is recommended.
Nota: Differenti lotti potrebbero essere soggetti a leggere variazioni di tonalità dipendenti dai differenti processi di produzione. Si raccomanda sempre di confrontare i colori prima della posa.
Note: La variation de l'ombre à travers les lots est inhérente au processus de fabrication et la comparaison de couleur avant la pose est recommandée.
Nota: La variación de tonalidad a través de los lotes es inherente al proceso de fabricación y es recomendable una comparación previa del color.

CARATTERISTICHE TECNICHE

TECHNICAL FEATURES | CARACTÉRISTIQUES TECHNIQUES |
CARACTERÍSTICAS TÉCNICAS

GRES PORCELLANATO A TUTTA MASSA (Bia - UGL) :

Le piastrelle in gres porcellanato a tutta massa sono prodotte utilizzando materie prime d’importazione pure e selezionate, miscelate utilizzando le tecniche di estrazione e selezione più avanzate; esse sono prodotte inoltre con un processo simile a quello utilizzato per le piastrelle in monocottura.

Le materie prime vengono sottoposte ad un processo di macinazione ad umido, seguito da essiccazione a spruzzo parziale, stoccaggio in silos per consentirne l’omogeneizzazione, quindi la miscela viene pressata mediante presse idrauliche ad alta efficienza fino a pressioni specifiche superiori a 500 kg/cm2. L’alta pressione, insieme all’alta temperatura di cottura, superiore ai 1200°C, produce una superficie ceramica molto compatta e resistente, con un rapporto di assorbimento dell’acqua molto basso (inferiore allo 0,1%, conformemente allo standard UNI EN ISO 10545-3) e una resistenza meccanica estremamente alta (valore medio superiore a 50 N/mm2, conformemente allo standard UNI EN ISO 10545-4).

Le piastrelle in gres porcellanato a tutta massa sono prodotti adatti per aree molto trafficate, dal momento che sono caratterizzate da un’alta resistenza all’abrasione (pari a 140 mm3 di materiale rimosso, contro i 175 mm3 di cui allo standard UNI EN ISO 10545-6).

Grazie alla bassa porosità, queste piastrelle in gres porcellanato a tutta massa sono a prova di gelo e classificate nel gruppo Bia UGL in base allo standard europeo UNI EN 14411, che richiede un livello di assorbimento dell’acqua ≤ 0,5%.

La resistenza chimica agli acidi e alle basi (UNI EN ISO 10545-13) rende le piastrelle in gres porcellanato a tutta massa adatte agli ambienti in cui vengono utilizzate sostanze chimiche forti, come industrie alimentari, ospedali e impianti chimici o farmaceutici. Le piastrelle in gres porcellanato non smaltato di RAK Ceramics sono disponibili in un’ampia gamma di dimensioni e superfici (disponibili anche con finitura anti-scivolo).

CONSIGLI PER LA POSA

Anche se le nostre piastrelle in gres porcellanato a tutta massa possono essere posate mediante malte cementizie tradizionali, consigliamo gli adesivi moderni. Per dimensioni superiori a 40x40cm, posa su pareti e all’esterno, si raccomanda il sistema di spargimento a due strati per bagnare perfettamente il retro della piastrella.

Immergere rapidamente in acqua ciascuna piastrella prima della posa servirà a rimuovere la polvere dal retro della piastrella al fine di una perfetta adesione; tuttavia, non bagnare le piastrelle quando si usano adesivi a base di resine acriliche o viniliche o adesivi a base di solventi organici a due componenti.

Quando si posa su pavimenti di ampie dimensioni è consigliabile incorporare idonei giunti di ritiro-flessione (giunti di movimento/espansione) che non devono mai essere distanziati più di 4-5 metri lineari l’uno dall’altro negli ambienti interni o 3 metri lineari negli ambienti esterni. Prestare attenzione quando si usano stucchi molto colorati, poiché potrebbero lasciare sulla superficie delle piastrelle macchie che potrebbero risultare difficili da rimuovere in seguito.



FULL BODY PORCELAIN TILES (BIA - UGL) :

Full body porcelain tiles are manufactured using pure, selectively imported raw materials mixed using the most advanced extraction and sorting techniques; they are obtained with a production process similar to that of single-fired tiles.

The resulting product is top-quality porcelain tile, obtained by raw materials wet grinding, followed by partial drying by spraying, silo storage to allow homogenization of properties, and pressing with highly efficient hydraulic presses up to specific pressures more than 500 kg/cm2. The high pressure combined with high firing temperature exceeding 1200 °C results in highly compact & strong ceramic surface with very low water absorption (lower than 0.1% according to UNI EN ISO 10545-3) and extremely high mechanical resistance (average value exceeding 50 N/mm2 according to UNI EN ISO 10545-4).

Full body porcelain are suitable for heavy traffic areas as they are characterized by a deep abrasion resistance (equal to 140 mm3 of removed material, as opposed to the 175 mm3 provided for by the UNI EN ISO 10545-6 standard).

Thanks to their low porosity, these tiles are frost-proof and rated as belonging to the Bia UGL class according to the European Standard UNI EN 14411 which requires water absorption ≤ 0.5%.

Chemical acid and base resistance (UNI EN ISO 10545-13) makes full body porcelain tiles suitable for environments where aggressive chemicals are used, e.g. food processing factories, hospitals, chemical or pharmaceutical plants. The full bod porcelain tiles are available in a wide range of sizes and surfaces (slip-resistant finish also available).

ADVICE ON LAYING

Although our full bod porcelain tiles can be installed using traditional cement mortars, we advise using modern adhesives. For large sizes over 40x40cm, outdoor and wall installations, the two-layer spreading system is recommended to perfectly wet the back of the tile.

Quickly dipping each tile in water before installation will remove any dust on the back of the tile for perfect adhesion. Do not wet the tiles if you are using vinyl, acrylic resin adhesives or two-component organic-solvent based adhesive.

It is advisable to incorporate suitable shrinkage - flexion joints (movement/ expansion joints) when installing on large floors: the joints should never be spaced more than 4 - 5 linear meters apart indoors and 3 linear meters apart outdoors. Be careful while using strong coloured grouts as they might leave stains on the surface of the tiles that may be difficult to remove later.



GRÈS CÉRAME PLEIN MASSE (BIA - UGL) :

Les grès cérame plein masse sont fabriqués à partir de matières premières pures sélectivement importées, mélangées à l’aide des techniques d’extraction et de tri des plus sophistiquées ; et leur fabrication nécessite un processus de production identique à celui des carreaux en monocuisson.

Les matières premières entament un processus de broyage humide suivi du séchage partiel par pulvérisation, du silotage pour assurer l’homogénéisation, puis le mélange est pressé grâce à des presses hydrauliques haute efficacité à une puissance de pressage spécifique de plus de 500 kg/cm2. Combinée à une température de cuisson élevée excédant 1200°C, la forte pression entraîne une surface céramique très compacte et solide à faible taux d’absorption d’eau (inférieur à 0,1% selon la norme UNI EN ISO 10545-3) et d’une résistance mécanique extrêmement élevée (valeur moyenne dépassant 50 N/mm2 selon la norme UNI EN ISO 10545-4).

Les grès cérame plein masse sont des produits complets appropriés pour les zones à trafic intense, car ils se caractérisent par une forte résistance à l’abrasion (équivalente à 140 mm3 de matériau enlevé, par rapport aux 175 mm3 prévus par la norme UNI EN ISO 10545-6).

Grâce à leur faible porosité, ces grès cérame plein masse sont résistent au gel et sont classés dans le groupe Bia UGL conformément à la norme européenne UNI EN 14411 exigeant un taux d’absorption d’eau ≤ 0,5%.

En raison de leur résistance de base et aux acides chimiques (UNI EN ISO 10545-13), les grès cérame plein masse conviennent aux environnement où sont utilisés des produits chimiques agressifs, notamment les usines de transformation d’aliments, les hôpitaux, les usines chimiques ou pharmaceutiques. Les grès cérame plein masse de RAK Ceramics sont disponibles dans un large éventail de tailles et surfaces (la finition antidérapante est également disponible).

RECOMMANDATIONS EN MATIÈRE DE POSE

Bien que nos grès cérame plein masse peuvent être posés à l’aide de mortiers de ciment traditionnels, nous recommandons l’utilisation de colles modernes. Pour la pose sur des murs et surfaces extérieures larges de plus de 40x40 cm, le système d’épandage bi-couches est recommandé pour bien humidifier l’envers du carreau.

Pour une meilleure adhésion, il est possible de plonger de manière rapide chaque carreau dans l’eau avant la pose. Cependant, évitez de mouiller les carreaux en cas d’utilisation de colles à base de résine acrylique ou vinylique ou en cas d’utilisation de colle à base de solvant organique bi-composants.

Il est recommandé d’utiliser des joints de retrait-flexion (joints de mouvement/dilatation) lors de la pose sur des grandes surfaces : les joints ne doivent jamais être espacés l’un de l’autre de plus de 4 à 5 mètres linéaires à l’intérieur et de 3 mètres linéaires à l’extérieur. Faites preuve de prudence en cas d’utilisation de coulis colorés solides, lesquels peuvent laisser, sur la surface des carreaux, des taches qui peuvent être difficiles à éliminer plus tard.



PORCELÁNICO TODO MASA (BIA - UGL) :

Los porcelánico todo masa porcelánico todo masa son elaborados utilizando material prima pura, importada selectivamente, mezclada utilizando las técnicas de extracción y clasificación más avanzadas; y son fabricados utilizando un proceso similar al utilizado con azulejos de cocción simple.

La materia prima pasa por un proceso de amolado húmedo, seguido por secado parcial con rociador, almacenamiento en silos para permitir la homogenización, y después la mezcla es prensada utilizando prensas hidráulicas de alta eficacia, que los lleva a presiones específicas de más de 500 kg/cm2. La alta presión combinada con una temperatura de cocción de más de 1200 °C resulta en una superficie cerámica altamente compacta y fuerte con poca absorción de agua (menor a 0.1% de acuerdo a la norma UNI EN ISO 10545-3) y resistencia mecánica extremadamente alta (el valor promedio sobrepasando 50 N/mm2 de acuerdo a la norma UNI EN ISO 10545-4).

Los porcelánico todo masa son productos completamente apropiados para áreas de tráfico pesado, ya que se caracterizan por una alta resistencia a la abrasión (igual a 140 mm3 de material eliminado, a diferencia de los 175 mm3 establecidos por la norma UNI EN ISO 10545-6).

Gracias a su baja porosidad, estos porcelánico todo masa son a prueba de escarcha y calificados como pertenecientes a la clase Bia UGL de acuerdo a la norma europea UNI EN 14411 la cual requiere absorción de agua ≤ 0.5%.

El ácido químico y la resistencia base (UNI EN ISO 10545-13) hace que los porcelánico todo masa sean apropiados para ambientes en donde se utilizan químicos agresivos, como por ejemplo fábricas procesadoras de alimentos, hospitales, o plantas químicas o farmacéuticas. Los porcelánico todo masa de RAK Ceramics están disponibles en una ancha gama de diseños, tamaños y acabados (también hay acabado antideslizante disponible).









SUGERENCIAS PARA SU COLOCACION







Aunque nuestros porcelánico todo masa pueden ser instalados utilizando morteros de cemento tradicionales, sugerimos utilizar adhesivos modernos. Para tamaños grandes de más de 40x40cm, exteriores e instalaciones de paredes, se recomienda el sistema de distribución de dos capas para humedecer perfectamente la parte posterior del azulejo.

El bañar rápidamente cada azulejo en agua antes de la instalación eliminará cualquier cantidad de polvo de la parte trasera del azulejo para una adhesión perfecta; sin embargo, no moje los azulejos si está utilizando vinil, adhesivos de resina de acrílico o adhesivo con base de solvente orgánico de dos componentes.

Se recomienda siempre incorporar juntas de dilatación -contracción (juntas de movimiento y expansión) apropiadas al instalar sobre pisos extensos: las juntas nunca deben ser colocadas a más de 4 o 5 metros lineales de espacio entre ellas en el interior, y 3 metros lineales de espacio entre ellas en el exterior. Tenga cuidado al utilizar lechada de color ya que pueden dejar manchas sobre la superficie de los azulejos que pueden ser difíciles de eliminar después.

CARATTERISTICHE TECNICHE - GRES PORCELLANATO A TUTTA MASSA (BIA - UGL)
TECHNICAL CHARACTERISTICS - FULL BODY PORCELAIN TILES (Bia - UGL) CARACTÉRISTIQUES TECHNIQUES - GRÉS
CÉRAME PLEIN MASSE (B1a - UGL)
CARACTERÍSTICAS TÉCNICAS - PORCELÁNICO TODO MASA (B1a - UGL)

Descrizione del testo Test Description Description d'essai Descripción de la Prueba	Metodo di prova Standard Test Method Méthode d'essai standard Método de Prueba Estándar	Requisiti previsti dalla norma ISO 13006 International Standard ISO 13006 Norme internationale ISO 13006 Norma Internacional ISO 13006	RAK Ceramics - Specifiche RAK Ceramics Specifications Spécifications RAK Ceramics RAK Ceramics Especificaciones	
			(Rettificato) (Rectified) (Rectifié) (Rectificado)	(Non rettificato) (Unrectified) (Non rectifié) (No rectificado)
 Lunghezza larghezza Length & Width Longueur & Largeur Longitud y Ancho	BS EN ISO 10545-2	+/- 0.6%	+/- 0.1%	+/- 0.3%
 Spessore Thickness Épaisseur Grosor	BS EN ISO 10545-2	+/- 0.5%	+/- 0.5%	+/- 0.5%
 Ortogonalità rettangolare Rectangle Squareness Rectangulaire Equerrage Cuadratura Rectangular	BS EN ISO 10545-2	+/- 0.6%	+/- 0.2%	+/- 0.4%
 Rettilineità dei lati Straightness of sides Rectitude des côtés Rectitud de los lados	BS EN ISO 10545-2	+/- 0.5%	+/- 0.2%	+/- 0.3%
 Planarità della superficie Surface Flatness Planéité de surface Horizontalidad de la Superficie	BS EN ISO 10545-2	+/- 0.5%	+/- 0.3%	+/- 0.3%
 Assorbimento dell'acqua Water Absorption Absorption d'eau Absorción de Agua	BS EN ISO 10545-3	<=0.5%	<=0.4%	<=0.4%
 Modulo di Rottura Modulus of Rupture Module de rupture Módulo de Rotura	BS EN ISO 10545-4	>=35 N/mm2	>=40 N/mm2	>=40 N/mm2
 Resistenza alla rottura Breaking Strength Résistance à la rupture Resistencia de Rotura	BS EN ISO 10545-4	>=1300N	>=1500N	>=1600N
 Resistenza all'abrasione superficiale profonda Resistance to deep surface abrasion Résistance à l'abrasion de surface profonde Resistencia a la Abrasion Superficial profunda	BS EN ISO 10545-7	<=175/mm3	<=150/mm3	<=150/mm3

Descrizione del testo Test Description Description d'essai Descripción de la Prueba	Metodo di prova Standard Test Method Méthode d'essai standard Método de Prueba Estándar	Requisiti previsti dalla norma ISO 13006 International Standard ISO 13006 Norme internationale ISO 13006 Norma Internacional ISO 13006	RAK Ceramics - Specifiche RAK Ceramics Specifications Spécifications RAK Ceramics RAK Ceramics Especificaciones	
			(Rettificato) (Rectified) (Rectifié) (Rectificado)	(Non rettificato) (Unrectified) (Non rectifié) (No rectificado)
 Dilatazione termica lineare Linear Thermal Expansion Dilatation thermique linéaire Expansión Térmica Lineal	BS EN ISO 10545-8	<=9x10 ⁻⁶ /C ⁴	<=7x10 ⁻⁶ /C ⁴	<=7x10 ⁻⁶ /C ⁴
 Resistenza agli shock termici Resistance to Thermal Shock Résistance aux chocs thermiques Resistencia al Choque Térmico	BS EN ISO 10545-9	Nessun difetto visibile No visible defect Aucun défaut visible Sin defectos visibles	Nessun difetto visibile No visible defect Aucun défaut visible Sin defectos visibles	Nessun difetto visibile No visible defect Aucun défaut visible Sin defectos visibles
 Resistenza alla screpolatura Crazing Resistance Résistance aux craquelures superficielles Resistencia al Agrietamiento	BS EN ISO 10545-11	Nessuna screpolatura No crazing Aucune craquelure Sin agrietamiento	Nessuna screpolatura No crazing Aucune craquelure Sin agrietamiento	Nessuna screpolatura No crazing Aucune craquelure Sin agrietamiento
 Resistenza al gelo Frost Resistance Résistance au gel Resistencia a la Congelación	BS EN ISO 10545-12	Nessun danno visibile No visible damage Aucun dommage visible Sin daños visibles	Nessun danno visibile No visible damage Aucun dommage visible Sin daños visibles	Nessun danno visibile No visible damage Aucun dommage visible Sin daños visibles
 Resistenza agli agenti chimici Resistance to chemicals Résistance aux produits chimiques Resistencia a los productos químicos	BS EN ISO 10545-13	Nessun effetto visibile No visible effect Aucun effet visible Sin efecto visibles	Nessun effetto visibile No visible effect Aucun effet visible Sin efecto visibles	Nessun effetto visibile No visible effect Aucun effet visible Sin efecto visibles
 Resistenza alle macchie Resistance to stains Résistance aux taches Resistencia a las Manchas	BS EN ISO 10545-14	Classe di abrasione Manufacturer to state class Le fabricant doit indiquer la classe Fabricado según lo especificado	Rimozione delle macchiemin. classe 4 Stain removed Min. class 4 Elimination des taches Min. classe 4 Min. remoción de manchas. Clase 4	Rimozione delle macchiemin. classe 4 Stain removed Min. class 4 Elimination des taches Min. classe 4 Min. remoción de manchas. Clase 4
 Resistenza dei colori alla luce UV Colour Resistance to UV Light Résistance des couleurs à la lumière UV Resistencia del Color a la luz UV	DIN 51094	Nessun cambiamento di colore No change in color Pas de changement de couleur Sin cambio de color	Nessun cambiamento di colore No change in color Pas de changement de couleur Sin cambio de color	Nessun cambiamento di colore No change in color Pas de changement de couleur Sin cambio de color

Note : Shade variation across the batches is inherent to the manufacturing process and the pre-laying colour comparison is recommended.
Nota: Differenti lotti potrebbero essere soggetti a leggere variazioni di tonalità dipendenti dai differenti processi di produzione. Si raccomanda sempre di confrontare i colori prima della posa.
Note: La variation de l'ombre à travers les lots est inhérente au processus de fabrication et la comparaison de couleur avant la pose est recommandée.
Hinweis: Durch den Herstellungsprozess kann es zu Farbabweichungen kommen. Es wird ein vorheriger Farbgleich empfohlen.
Nota: La variación de tonalidad a través de los lotes es inherente al proceso de fabricación y es recomendable una comparación previa del color.
Примечание: Производственному процессу свойственна вариация оттенков в зависимости от партии, в связи с чем перед укладкой рекомендуется провести цветное сравнение.

CARATTERISTICHE TECNICHE

TECHNICAL FEATURES | CARACTÉRISTIQUES TECHNIQUES |
CARACTERÍSTICAS TÉCNICAS

CERAMICA A PASTA ROSSA E A PASTA BIANCA (BIII) :

Le piastrelle di ceramica a pasta rossa e a pasta bianca sono prodotte con argille e chamotte (materia prima ceramica con un’alta percentuale di silicio) della migliore qualità. Le materie prime vengono miscelate attraverso un processo chiamato macinazione a secco e quindi pressate con presse idrauliche. Segue un ciclo rapido di cottura in forni rotanti alla temperatura massima di circa 1100°C. Dopo la biscottatura di vetrinatura, il prodotto smaltato viene sintetizzato in un forno rotante a singolo strato a circa 1030°C. Le piastrelle ottenute hanno una resistenza a flessione media superiore a 15/mm2, conformemente allo standard UNI EN ISO10545-4 e un livello di assorbimento idrico superiore al 10%, il che le classifica nel gruppo BIII GL in base allo standard UNI EN 14411. Questa classe di prodotti non mostra praticamente alcun ritiro durante la cottura; una consistenza di questo tipo consente pertanto una posa estremamente facile.

CONSIGLI PER LA POSA

Le piastrelle di ceramica a pasta rossa o bianca possono essere posate sia utilizzando adesivi per piastrelle che malta cementizia. In nessun caso le piastrelle devono essere bagnate prima della posa quando si usano adesivi a base di resine acriliche o viniliche o adesivi a base di solventi organici a due componenti. Quando si posano piastrelle di dimensioni maggiori, è meglio utilizzare il sistema di spargimento a due strati e, quando la superficie di posa è molto ampia, fornire idonei giunti di espansione a non più di 4-5 metri lineari l’uno dall’altro.

PUNTI IMPORTANTI DA RICORDARE DURANTE LA POSA DI QUESTE PIASTRELLE

- Quando si posa su cemento o intonaco bagnato, lasciare asciugare per almeno una settimana per ciascun centimetro di spessore.
- Quando si posa su mattoni, non usare mai adesivo per piastrelle di spessore superiore a 4-5 mm. Per la posa su supporti flessibili (per esempio pannelli di cartongesso, pannelli polimerici, ecc.) che possono provocare movimenti nelle piastrelle, consigliamo di posare con adesivo per piastrelle di spessore non superiore a 2-3 mm e di utilizzare colle di classe C2 o D1.
- Per la posa su mattoni impermeabili, che impediscono l’eliminazione dell’umidità, consigliamo di posare con adesivo per piastrelle di spessore non superiore a 3 mm e di utilizzare colle di classe C2 o D1.
- Evitare di posare senza giunti di espansione o con giunti in cui la tensione di espansione è scaricata direttamente sulla piastrella.



RED BODY AND WHITE BODY CERAMIC TILES (BIII):

Red body and white body Ceramic tiles are made with finest quality clays and with chamotte (a ceramic raw material with high percentage of silica). These raw materials are submitted to dry grinding and suitably mixed and wet and then pressed with hydraulic presses. Quick-cycle support firing is obtained via roller kilns reaching temperatures of approximately 1100 °C. After biscuit glazing, the vitrified product is sintered in a single-layer roller kiln at approximately 1030 °C. The resulting wall tiles have an average bending strength that is higher than 15/ mrrr in accordance with the UNI EN ISO10545-4 standard and a water absorption level that is higher than 10 %; they belong to the BIII (GL) group according to the UNI EN 14411 standard. This class of products shows virtually no shrinkage during firing; therefore such dimensional consistency results in extremely easy laying.

ADVICE ON LAYING

Ceramic Red/ White body tiles can be laid using either tile adhesives or cement mortar. Under no circumstances should the tiles be wet before laying when using acrylic or vinyl resin based adhesives or two- component organic solvent based adhesives. When laying large sized tiles it is best to adopt the two layer spreading method and, when the laying surface is very large, to provide for suitable expansion joints which must not be spaced more than 4-5 linear meters apart from one another.

IMPORTANT POINTS TO REMEMBER WHILE LAYING THESE TILES

- When laying on wet concrete or plaster, leave to dry for at least one week for each centimetre of thickness.
- When laying on brick, never lay on tile adhesive measuring more than 4-5 mm in thickness. For laying on flexible supports (for example plasterboard panels, polymer panels, etc.) which may result in movement of the tiles, we advise laying on tile adhesive measuring no more than 2-3 mm in thickness and to use class C2 or D1 glues.
- For laying on waterproof brick, which prevents the release of damp, we advise laying on tile adhesive measuring no more than 3 mm in thickness and to use class C2 or D1 glues.
- Avoid laying without expansion joints or joints where stress due to expansion is released directly onto the tile.



CARREAUX CÉRAMIQUES À PÂTE ROUGE ET PÂTE BLANCHE (BIII) :

Les carreaux céramique à pâte rouge ou blanche sont faits à base d’argile et de chamotte de très haute qualité (une matière première céramique à forte teneur en silice). Les matières premières sont mélangées grâce à un procédé appelé broyage à sec, puis pressées à l’aide de presses hydrauliques. La cuisson à cycle rapide se fait ensuite à l’aide de fours à rouleaux dont les températures sont d’environ 1100°C. Après l’émaillage de biscuits, le produit vitrifié est fritté dans un four à rouleaux monocouche à environ 1030°C. Les carreaux muraux obtenus ont une résistance à la flexion moyenne supérieure à 15/mm2 conformément à la norme UNI EN ISO10545-4 et un taux d’absorption d’eau supérieur à 10% ; classés dans le groupe BIII GL conformément à la norme UNI EN 14411 Ce groupe de produits ne présente pratiquement aucune retraita pendant la cuisson et par conséquent, une telle stabilité dimensionnelle facilite considérablement la pose.

RECOMMANDATIONS EN MATIÈRE DE POSE

Les carreaux céramiques en pâte rouge ou blanche peuvent être posés soit à l’aide de colles pour carrelage, soit à l’aide de mortier de ciment. Les carreaux ne doivent en aucun cas être humides avant la pose en cas d’utilisation de colles à base de résine acrylique ou vinylique ou en cas d’utilisation de colles à base de solvant organique bi-composants. Lors de la pose de carreaux de grande taille et lorsque la surface de pose est assez importante, il est préférable d’adopter le procédé d’épandage bi-couches, pour garantir des joints de dilatation appropriés qui ne doivent pas être espacés de plus de 4 à 5 mètres linéaires l’un de l’autre.

POINTS IMPORTANTS À PRENDRE EN CONSIDÉRATION LORS DE LA POSE DE CES CARREAUX

- Lors de la pose sur du béton ou du plâtre frais, laissez sécher pendant au moins une semaine pour chaque centimètre d’épaisseur.
- Lors de la pose sur des briques, évitez de poser sur de la colle pour carrelage de plus de 4 à 5 mm d’épaisseur. Pour la pose sur des supports flexibles (par exemple plaques de plâtre, panneaux de polymère, etc.) pouvant impliquer la mobilité des carreaux, nous vous recommandons de poser sur la colle pour carrelage d’une épaisseur ne dépassant pas 2 à 3 mm et d’utiliser du mortier-colle de classe C2 ou D1.
- Pour la pose sur des briques imperméables ne refoulant pas d’humidité, nous vous recommandons de poser sur la colle pour carrelage d’une épaisseur ne dépassant pas 3 mm et d’utiliser du mortier-colle de classe C2 ou D1.
- Évitez de poser sans joints de dilatation ou des joints où la contrainte, en raison de la dilatation, est directement exercée sur le carreau.



CERÁMICA PASTA ROJA Y BLANCA (BIII) :

Los azulejos cerámicos en rojo y blanco son elaborados con arcilla y chamota (una materia prima de cerámica con un alto porcentaje de sílice) de la mejor calidad. Las materias primas se mezclan utilizando un proceso llamado amolado seco y después son prensadas utilizando presas hidráulicas. Un horneado de apoyo en ciclo rápido sigue en el proceso utilizando hornos rotativos que alcanzan temperaturas de aproximadamente 1100 °C. Después del vidriado, el producto vitrificado se sinteriza en un horno rotativo de una sola capa a aproximadamente 1030 °C. Los azulejos de pared resultantes tienen una resistencia de flexión promedio de más de 15/mm2 de acuerdo a la norma UNI EN ISO10545-4 y un nivel de absorción de agua de más del 10 %; clasificado como perteneciente al grupo BIII GL de acuerdo a la norma UNI EN 14411. Esta clase de productos virtualmente muestra una nada de merma al momento de su cocción, y es a esto que se deben tales resultados de consistencia dimensional en una colocación extremadamente fácil.

SUGERENCIAS PARA SU COLOCACION

Los azulejos cerámicos en rojo o blanco pueden ser colocados utilizando ya sean adhesivos de azulejos o morteros de cemento. Los azulejos no deben estar húmedos bajo ninguna circunstancia antes de su colocación al utilizar adhesivos hechos con resina de vinil o resina acrílica, o adhesivos con base de solventes orgánicos con dos componentes. Al colocar azulejos de gran tamaño, es mejor adoptar el método de distribución de dos capas, y cuando la superficie de colocación es muy extensa, proporcionar juntas de dilatación apropiadas, las cuales no deben tener un espacio de más de 4 a 5 metros lineales entre cada una.

PUNTOS IMPORTANTES A RECORDAR AL COLOCAR ESTOS AZULEJOS

- Cuando se coloquen sobre concreto o yeso húmedo, deje secar por lo menos durante una semana por cada centímetro de grosor.
- Cuando coloque un ladrillo, nunca lo coloque sobre adhesivo de azulejos que mida más de a 5 mm de grosor. Para colocar sobre soportes flexibles (como por ejemplo paneles de yeso, paneles de polímero, etc.), lo que puede resultar en movimiento de los azulejos; sugerimos colocar sobre un adhesivo de azulejos que no mida más de 2 a 3 mm en grosor y utilizar pegamentos clase C2 o D1.
- Para colocar sobre ladrillos a prueba de agua, los cuales previenen la liberación de humedad, sugerimos colocar los azulejos sobre adhesivo de azulejos que no midan más de 3 mm de grosor, y utilizar pegamentos clase C2 o D1.
- Evite la colocación de los azulejos sin juntas de dilatación o donde la presión debido a la expansión se libera de forma directa en el azulejo.

CARATTERISTICHE TECNICHE - CERAMICA A PASTA ROSSA E A PASTA BIANCA (BIII)
TECHNICAL CHARACTERISTICS - RED BODY AND WHITE BODY CERAMIC TILES (BIII)
CARACTÉRISTIQUES TECHNIQUES - CARREAUX CÉRAMIQUES À PÂTE ROUGE ET PÂTE BLANCHE (BIII)
CARACTERÍSTICAS TÉCNICAS - CERÁMICA PASTA ROJA O BLANCA (BIII)

	Descrizione del test Test Description Description d'essai Descripción de la Prueba	Metodo di prova Standard Test Method Méthode d'essai standard Método de Prueba Estándar	Requisiti previsti dalla norma ISO 13006 International Standard ISO 13006 Norme internationale ISO 13006 Norma Internacional ISO 13006	RAK Ceramics - Specifiche RAK Ceramics Specifications Spécifications RAK Ceramics RAK Ceramics Especificaciones
	Lunghezza larghezza Length & Width Longueur & Largeur Longitud y Ancho	BS EN ISO 10545-2	+/- 0,5%	+/- 0,3%
	Spessore Thickness Épaisseur Grosor	BS EN ISO 10545-2	+/-10%	+/- 5,0%
	Ortogonalità rettangolare Rectangle Squareness Rectangulaire Équerrage Cuadratura Rectangular	BS EN ISO 10545-2	+/- 0,5%	+/- 0,4%
	Rettilineità dei lati Straightness of sides Rectitude des côtés Rectitud de los lados	BS EN ISO 10545-2	+/- 0,3%	+/- 0,3%
	Planarità della superficie Surface Flatness Planéité de surface Horizontalidad de la Superficie	BS EN ISO 10545-2	+0,5% / -0,3%	+/- 0,3%
	Assorbimento dell'acqua Water Absorption Absorption d'eau Absorción de Agua	BS EN ISO 10545-3	10% < E <= 20%	10% < E <= 18%
	Modulo di Rottura Modulus of Rupture Module de rupture Módulo de Rotura	BS EN ISO 10545-4		
	Spessore > = 7,5mm Thickness > = 7,5mm Épaisseur > = 7,5mm Grosor > = 7,5mm		>=12 N/mm2	>=16 N/mm2
	Spessore < = 7,5mm Thickness < = 7,5mm Épaisseur < = 7,5mm Grosor < = 7,5mm		>=15 N/mm2	>=16 N/mm2

	Test Description Description del test Description d'essai Descripción de la Prueba	Standard Test Method Metodo di prova Méthode d'essai standard Método de Prueba Estándar	International Standard ISO 13006 Requisiti previsti dalla norma ISO 13006 Norme internationale ISO 13006 Norma Internacional ISO 13006	RAK Ceramics Specifications RAK Ceramics - Specifiche Spécifications RAK Ceramics RAK Ceramics Especificacione
	Resistenza alla rottura Breaking Strength Résistance à la rupture Resistencia de Rotura	BS EN ISO 10545-4		
	Spessore > = 7,5mm Thickness > = 7,5mm Épaisseur > = 7,5mm Grosor > = 7,5mm		>=600N	>=650N
	Spessore < = 7,5mm Thickness < = 7,5mm Épaisseur < = 7,5mm Grosor < = 7,5mm		>=200N	>=400N
	Resistenza all'abrasione superficiale Resistance to surface abrasion Résistance à l'abrasion de surface Resistencia a la Abrasión Superficial	BS EN ISO 10545-7	Classe di abrasione indicata dal produttore Manufacturer to state Abrasion Class Le fabricant doit indiquer la classe d'abrasion Fabricado según el tipo de abrasión especificado	Classe 2-4 Class 2 - 4 Classe 2 - 4 Clase 2 - 4
	Resistenza agli shock termici Resistance to Thermal Shock Résistance aux chocs thermiques Resistencia al Choque Térmico	BS EN ISO 10545-9	Nessun effetto visibile No visible effect Aucun effet visible Sin efecto visibles	Nessun effetto visibile No visible effect Aucun effet visible Sin efecto visibles
	Resistenza alla screpolatura Crazing Resistance Résistance aux craquelures superficielles Resistencia al Agrietamiento	BS EN ISO 10545-11	Nessuna screpolatura No crazing Aucune craquelure Sin agrietamiento	Nessuna screpolatura No crazing Aucune craquelure Sin agrietamiento
	Resistenza agli agenti chimici Resistance to chemicals Résistance aux produits chimiques Resistencia a los productos químicos	BS EN ISO 10545-13	Nessun effetto visibile No visible effect Aucun effet visible Sin efecto visibles	Nessun effetto visibile No visible effect Aucun effet visible Sin efecto visibles
	Resistenza alle macchie Resistance to stains Résistance aux taches Resistencia a las Manchas	BS EN ISO 10545-14	Classe di abrasione Manufacturer to state class Le fabricant doit indiquer la classe Fabricado según lo especificado	Rimozione delle macchiemin. classe 4 Stain removed Min. class 4 Elimination des taches Min. classe 4 Min. remoción de manchas. Clase 4
	Indice di durezza (Moh's) Scratch Hardness : (Moh's) Dureté à la rayure : (Moh's) Dureza al Rayado: (Moh's)	EN 101		4 - 6

Note : Shade variation across the batches is inherent to the manufacturing process and the pre-laying colour comparison is recommended.
 Nota: Differenti lotti potrebbero essere soggetti a leggere variazioni di tonalità dipendenti dai differenti processi di produzione. Si raccomanda sempre di confrontare i colori prima della posa.
 Note: La variation de l'ombre à travers les lots est inhérente au processus de fabrication et la comparaison de couleur avant la pose est recommandée.
 Nota: La variación de tonalidad a través de los lotes es inherente al proceso de fabricación y es recomendable una comparación previa del color.

MANUTENZIONE E PULIZIA DELLE PIASTRELLE

MAINTENANCE AND CLEANING OF TILES | ENTRETIEN ET NETTOYAGE DES CARREAUX |
MANTENIMIENTO Y LIMPIEZA DE AZULEJOS

La manutenzione delle piastrelle ceramiche e porcellanate su superfici asciutte è relativamente semplice. Le piastrelle RAK Ceramics sono altamente resistenti ai graffi e alle macchie.

- Spazzando regolarmente il pavimento si contribuisce ad evitare eventuali graffi che possono essere causati da sabbia o pietrisco.
- Prendere l'abitudine di pulire la suola delle scarpe su uno zerbino prima di entrare in casa. Eliminare accuratamente ogni eventuale liquido versato mediante acqua naturale calda.
- Anche se è improbabile che macchino le piastrelle, eventuali liquidi versati possono macchiare lo stucco tra le piastrelle e se li si lascia agire troppo a lungo possono anche macchiare le piastrelle vere e proprie.
- L'acqua naturale è il detergente ideale perché non lascia residui se si asciuga attentamente la superficie delle piastrelle dopo la pulizia.
- Se le piastrelle vengono lasciate bagnate dopo la pulizia, quando l'acqua asciuga potrebbero verificarsi residui antiestetici, ma questi possono essere facilmente rimossi.
- Se in seguito alla pulizia con acqua naturale restano delle macchie, è possibile utilizzare una soluzione blandamente acida, come l'aceto bianco. Usarlo in forma diluita e sciacquare con acqua naturale, quindi asciugare.
- Poiché le macchie alimentari sono naturalmente acide, provare usando una soluzione leggermente alcalina.
- Usare i comuni detersivi con parsimonia, sciacquare con acqua naturale e asciugare con cura.



Maintenance of ceramic and porcelain tiles on dry surfaces is relatively easy. RAK Ceramics tiles are highly scratch and stain resistant.

- By regularly sweeping the floor, you can help avoid scratches that small pebbles or sand can create.
- Make it a habit to always wipe the soles of your shoes on a mat before entering the house. Thoroughly wipe up any spills using plain warm water.
- While they are not likely to stain your ceramic tiles, spills may stain the grout between the tiles and if they are left to sit for too long, may also stain the actual tiles.
- Plain water is the ideal cleaner because it leaves no residue if you dry the surface of the tiles thoroughly after cleaning.
- If tiles are left wet after cleaning, there may be some unsightly mineral residue after the water dries, but this can easily be removed by spot cleaning.
- If stains resist cleaning with water alone, you can use a mild acidic solution, such as white vinegar. Use it highly diluted and rinse with plain water then dry.
- As food stains are acidic in nature, try using a mild alkaline solution.
- Use common detergents sparingly, rinse with plain water and dry thoroughly.



L'entretien des carreaux de céramique et de porcelaine sur des surfaces sèches est relativement facile. Les carreaux de RAK Ceramics ont une résistance remarquable aux rayures et aux taches.

- Le balayage régulier du sol permet d'éviter les éraflures que peuvent laisser les petits cailloux ou le sable.
- Prenez l'habitude de toujours nettoyer les semelles de vos chaussures sur un paillasson avant d'entrer dans la maison. Nettoyez soigneusement les déversements à l'aide d'eau ordinaire tiède.
- Bien qu'ils ne puissent pas tacher vos carreaux de céramique, les déversements peuvent teindre le coulis entre les carreaux. Par ailleurs, s'ils sont laissés pendant de longues durées, ces déversements peuvent également teindre les carreaux actuels.
- L'eau ordinaire est le nettoyeur idéal car elle ne laisse aucun résidu lorsque vous séchez correctement la surface des carreaux après le nettoyage.
- Si les carreaux sont laissés humides après leur nettoyage, de résidus minéraux inesthétiques peuvent être notés après que l'eau ait séché, mais cela peut être facilement enlevé par un détachant.
- Si la tache résiste au nettoyage à l'eau, vous pouvez utiliser une solution acide douce comme le vinaigre blanc. Utilisez-le à l'état très dilué et rincez avec de l'eau ordinaire, puis séchez.
- Étant donné que les taches d'aliments sont de nature acides, essayez d'utiliser une solution alcaline douce.
- Utilisez des détergents usuels de manière modérée, rincez avec de l'eau ordinaire et séchez soigneusement.



El mantenimiento de azulejos de cerámica y porcelana en superficies secas es relativamente fácil. Los azulejos de RAK Ceramics son altamente resistentes a rayones y manchas.

- Al barrer regularmente el piso, puede ayudar a evitar rayones que piedras pequeñas o arena pueden crear.
- Haga de limpiar las suelas de sus zapatos en una alfombra antes de entrar a la casa un hábito. Limpie minuciosamente cualquier derrame utilizando agua tibia.
- Aunque no es probable que manchen sus azulejos de cerámica, los derrames pueden manchar la lechada que se encuentra entre los azulejos y si se deja reposar por mucho tiempo, también puede manchar los azulejos mismos.
- El agua simple es el limpiador ideal porque no deja residuos si seca la superficie de los azulejos cuidadosamente después de limpiar.
- Si los azulejos se dejan mojados después de limpiarlos, puede que queden residuos minerales difíciles de ver a simple vista después de que se seque el agua; estos pueden ser fácilmente eliminados con limpieza de rutina.
- Si alguna mancha se resiste a la limpieza solo con agua, puede utilizar una solución ácida suave, como el vinagre blanco. Utilícelo bien diluido, lave con agua y séquelo al final.
- Debido a que las manchas de comida son naturalmente ácidas, intente utilizando una solución alcalina suave.
- Utilice detergentes comunes de vez en cuando, lave con agua y seque minuciosamente.

CONDIZIONI GENERALI DI VENDITA

GENERAL TERMS OF SALE | CONDITIONS GÉNÉRALES DE VENTE | TÉRMINOS GENERALES DE VENTA

1 NORMATIVA CONTRATTUALE

Le presenti condizioni generali, salvo modificazioni o deroghe concordate per iscritto, disciplinano tutti i contratti di vendita fra RAK Ceramics Distribution Europe S.R.L. e l'Acquirente. Le variazioni delle condizioni generali di vendita, le offerte, gli accrediti o gli abbuoni accordati dai nostri agenti o altri intermediari, non sono validi se non accettate per iscritto dai soggetti autorizzati presso la nostra sede legale. Si intendono applicabili, in ogni caso, le condizioni generali vigenti al momento della stipula del contratto.

Le presenti condizioni generali non riguardano e non disciplinano le vendite on line dei prodotti RAK Ceramics Distribution Europe S.R.L..

2 OGGETTO DELLA FORNITURA

La fornitura comprende solamente i materiali, le prestazioni ed i quantitativi specificati nella nostra conferma d'ordine. Il testo della conferma d'ordine RAK Ceramics Distribution Europe S.R.L. prevarrà in ogni caso sul testo eventualmente difforme dell'offerta o dell'ordine.

3 CONFERMA D'ORDINE

Qualora nella conferma d'ordine RAK Ceramics Distribution Europe S.R.L. esistano differenze nei singoli elementi che la compongono rispetto precedenti intese od all'ordine, l'Acquirente che non abbia contestato entro sette giorni dalla ricezione della nostra conferma s'intende che l'abbia accettata così come è stata redatta. In particolare, l'accettazione senza riserve della conferma d'ordine comporta, per espresso patto contrattuale l'accettazione delle condizioni generali riportate nella stessa.

Il cliente si impegna a comunicare a RAK Ceramics Distribution Europe S.R.L. l'eventuale variazione del luogo di destinazione della merce, se diverso da quello citato nella conferma d'ordine, entro e non oltre il giorno previsto per il ritiro presso RAK Ceramics Distribution Europe S.R.L., mediante invio, tramite posta, fax o e-mail, dei dati identificativi del destinatario delle merci e/o del luogo presso il quale dovrà essere effettuata la consegna. In mancanza di tale comunicazione la destinazione originariamente indicata si intende tacitamente confermata.

4 PREZZI

I prezzi indicati sui listini RAK Ceramics Distribution Europe S.R.L. non sono impegnativi: di conseguenza ci riserviamo il diritto di modificarli prima dell'accettazione dell'ordine. I prezzi pattuiti per ogni singola vendita si intendono al netto, per contanti per consegna franco stabilimento, salvo diversa pattuizione scritta. Se fra la data di ordinazione (anche dopo la conferma d'ordine) e quella di consegna si verificassero aumenti nei costi delle materie prime, della manodopera, dei combustibili, nelle spese di produzione, di trasporto ecc., RAK Ceramics Distribution Europe S.R.L. potrà aumentare il prezzo convenuto dandone comunicazione scritta all'Acquirente anche a mezzo fax o posta elettronica.

5 CONSEGNE

La vendita è sempre franco stabilimento di RAK Ceramics Distribution Europe S.R.L.. La merce viaggia a rischio e pericolo dell'Acquirente ed ogni nostra responsabilità cessa con la consegna al vettore, nei confronti del quale l'Acquirente, effettuate le opportune verifiche, dovrà sporgere eventuali reclami. Le spedizioni, via mare o via terra, concernenti forniture sull'estero, vengono effettuate in base alle condizioni scelte di volta in volta, riportate negli “Incoterms” approvati dalla camera di Commercio Internazionale.

6 TERMINI DI CONSEGNA

I termini di consegna hanno carattere indicativo; eventuali ritardi nelle consegne, interruzioni, sospensioni totali o parziali delle forniture non daranno diritto ad indennizzi o risarcimento danni se non diversamente concordato per iscritto. In ogni caso, non saranno risarcibili danni non derivati da fatti non imputabili a RAK Ceramics Distribution Europe S.R.L..

7 CAMPIONI

I dati, le immagini, i filmati, ecc., raffigurati nei cataloghi, nel materiale illustrativo, informativo e/o pubblicitario di RAK Ceramics Distribution Europe S.R.L., così come le caratteristiche dei campioni e modelli da quest'ultima inviati all'Acquirente, hanno carattere unicamente illustrativo e non sono vincolanti per RAK Ceramics Distribution Europe S.R.L.. Questi dati non hanno valore impegnativo se non nella misura in cui siano stati espressamente menzionati come tali nell'offerta o nell'accettazione scritta di RAK Ceramics Distribution Europe S.R.L..

8 PAGAMENTI

Le fatture di RAK Ceramics Distribution Europe S.R.L. vengono emesse il giorno della fornitura e devono essere pagate al netto o alla scadenza pattuita. Ogni e qualsiasi obbligazione di pagamento tra le parti contraenti deve essere adempiuta presso la sede della RAK Ceramics Distribution Europe S.R.L.. Eventuali pagamenti fatti ad agenti, rappresentanti o ausiliari di commercio di RAK Ceramics Distribution Europe S.R.L. non si intendono andati a buon fine finché le relative somme non pervengano a RAK Ceramics Distribution Europe S.R.L.. Il pagamento dovrà essere effettuato, salvo diverso accordo scritto, contestualmente alla consegna, presso l'Istituto bancario indicato di RAK Ceramics Distribution Europe S.R.L.. Qualsiasi ritardo o irregolarità nel pagamento dà a RAK Ceramics Distribution Europe S.R.L. il diritto di sospendere le forniture e/o di risolvere i contratti in corso, anche se non relativi ai pagamenti in questione, nonché il diritto al risarcimento degli eventuali danni. RAK Ceramics Distribution Europe S.R.L. ha comunque diritto – a decorrere dalla scadenza del pagamento, senza necessità di messa in mora – agli interessi moratori nella misura prevista dal d.lgs. 09/10/2002 n. 231. L'inadempimento, anche solo parziale, comporterà la decadenza del beneficio del termine per il cliente; gli interessi moratori sull'importo non pagato decorreranno dal giorno della consegna anche se il termine di pagamento era stato convenuto in data successiva. Nessuna contestazione o controversia inerente la qualità della merce, vizi o difetti, e/o a qualsiasi altro aspetto del contratto, potrà essere presa in considerazione, iniziata e/o azionata, se non dopo l'avvenuto integrale pagamento del prezzo (clausola solve et repete). Non è ammessa compensazione con eventuali crediti, comunque insorti, nei confronti di RAK Ceramics Distribution Europe S.R.L..

9 GARANZIE E RECLAMI

La qualità del materiale ceramico è definita sulla base delle vigenti normative internazionali applicabili alla corrispondente classe di prodotto. RAK Ceramics Distribution Europe S.R.L. garantisce la sola merce fornita in prima scelta. Reclami relativi a merce in scelta differente dalla prima (scelta B, commerciale, seconda, terza, secondaria, stock, etc.) non saranno presi in considerazione e/o accettati, né viene fornita implicitamente od esplicitamente alcun tipo di garanzia su tali materiali. E' fatto obbligo all'Acquirente di verificare la merce in termini di qualità e quantità entro e non oltre 8 (otto) giorni dal ricevimento stesso pena la decadenza da ogni diritto. Il materiale considerato difettoso dovrà essere tenuto a disposizione di RAK Ceramics Distribution Europe S.R.L. per le verifiche che riterrà opportuno effettuare; ogni ulteriore azione (restituzione, riparazione, o altro) dovrà essere preventivamente autorizzata per iscritto. Reclami e richieste di intervento in garanzia dopo la posa in opera non saranno presi in esame e/o accettati nel caso in cui il difetto contestato dovesse risultare palese (es. sbeccate, difetti dimensionali, differenze di tono, ecc.). Si precisa che la prima scelta può contenere piastrelle difettose nel limite del 5% e che la tonalità del materiale fornito può differire dal campione esposto, essendo la ceramica intrinsecamente variabile come aspetto. I reclami imputati a difetti o vizi occulti dovranno essere formalizzati per iscritto entro 8 (otto) giorni dalla scoperta e, in ogni caso, entro un anno dalla consegna l'azione di garanzia si prescrive a norma di legge. La comunicazione dovrà contenere, oltre i dati di fatturazione, una precisa descrizione del vizio, un preventivo dei costi di riparazione o modificazione del prodotto; in mancanza di questi dati il reclamo non verrà accettato. Qualora il reclamo dovesse risultare infondato l'Acquirente dovrà risarcire RAK Ceramics Distribution Europe S.R.L. di tutte le spese sostenute per l'accertamento (viaggi, perizie, spese legali, ecc.). L'obbligo di RAK Ceramics Distribution Europe S.R.L. è, in ogni caso, limitato alla sostituzione dei soli pezzi difettosi o alla riparazione, con espressa esclusione di ulteriori diversi indennizzi quali, a titolo indicativo ma non limitativo, costi di rimozione e risistemazione di mobilio, attrezzature, macchinari, ecc., mancati guadagni per interruzione o sospensione di attività, disagi, danni indiretti, ecc. La presenza di piastrelle difettose non inficia la qualità dell'intera fornitura, né comporta l'obbligo della integrale sostituzione. I limiti temporali della durata della garanzia sono quelli stabiliti dal codice civile italiano.

10 RISERVATO DOMINIO

La vendita della merce viene effettuata con la clausola del riservato dominio; pertanto, nel caso in cui il pagamento, per accordi contrattuali, debba essere effettuato, in tutto o in parte, dopo la consegna, i prodotti consegnati restano di proprietà RAK Ceramics Distribution Europe S.R.L. fino all'integrale pagamento del prezzo.

11 CESSIONE DEL CONTRATTO

L'acquirente non può cedere il contratto od i singoli rapporti obbligatori da questo derivanti senza l'accettazione scritta di RAK Ceramics Distribution Europe S.R.L.; anche in tal caso l'Acquirente rimane comunque solidalmente responsabile col cessionario per le obbligazioni cedute.

12 PROPRIETA' INDUSTRIALE E DISTRIBUZIONE SELETTIVA – LIMITI ALLA RIVENDITA

RAK Ceramics Distribution Europe S.R.L. è titolare e legittimo detentore di esclusive relative ai marchi, a disegni e brevetti di invenzione. Al fine di garantire al meglio il rispetto dei diritti esclusivi di RAK Ceramics Distribution Europe S.R.L., nonché le aspettative dei consumatori finali in ordine alla caratteristiche qualitative attese, RAK Ceramics Distribution Europe S.R.L. gestisce le forniture dei propri prodotti mediante un sistema di distribuzione selettiva. Le forniture ricevute da RAK Ceramics Distribution Europe S.R.L. e dai suoi punti vendita selettivi autorizzati sono destinate all'installazione presso l'utente finale e non è consentita altra forma di rivendita a ulteriori intermediari commerciali diversi dagli utenti finali, salvo previa autorizzazione scritta da parte di RAK Ceramics Distribution Europe S.R.L.. La rivendita della merce in violazione di tale divieto deve considerarsi pertanto non consentita ed equiparata ad uso illecito dei diritti di proprietà industriale e intellettuale di RAK Ceramics Distribution Europe S.R.L., con diritto di RAK Ceramics Distribution Europe S.R.L. di chiederne il sequestro presso qualunque detentore. In particolare, è vietata la vendita online e/o canali distributivi simili e/o analoghi, se non preventivamente autorizzata per iscritto da RAK Ceramics Distribution Europe S.R.L., così come la vendita a soggetti che utilizzano tale canale distributivo. Il rivenditore che venisse a conoscenza di tali pratiche di vendita deve immediatamente sospendere le forniture ed avvisare per iscritto RAK Ceramics Distribution Europe S.R.L.. Qualora ciò non avvenga sarà considerato responsabile solidale nei confronti di RAK Ceramics Distribution Europe S.R.L. per risarcimenti, danni e quant'altro. RAK Ceramics Distribution Europe S.R.L. si riserva il diritto di procedere giudizialmente nei confronti di chiunque sia coinvolto in rivendite non autorizzate.

13 LEGGE DEL CONTRATTO – FORO COMPETENTE

Il contratto è disciplinato dalla legge italiana, compresi gli usi di settore della Provincia di Modena. Per qualsiasi controversia comunque derivante dal contratto di fornitura, tanto da parte di RAK Ceramics Distribution Europe S.R.L. come da parte dell'Acquirente, è esclusivamente competente il Tribunale di Modena, con esclusione di ogni altro. E' comunque in facoltà di RAK Ceramics Distribution Europe S.R.L. adire autorità giudiziarie diverse.

14 SICUREZZA DELLA CATENA LOGISTICA

RAK Ceramics Distribution Europe S.R.L. al fine di garantire la sicurezza logistica internazionale richiede ai propri clienti il rispetto di requisiti standard per garantire la sicurezza delle merci nei rapporti contrattuali e per garantire la loro conformità alla normativa AEO – Operatore Economico Autorizzato – Dogane, in tutta la Comunità Europea. I clienti di RAK Ceramics Distribution Europe S.R.L. si impegnano a garantire che le merci prese in consegna o consegnate siano spedite o trasportate, immagazzinate, preparate e caricate in locali sicuri e in zone di carico e di spedizione sicure, protette contro manomissioni non autorizzate, utilizzando solo personale interno autorizzato ed opportunamente istruito.

GENERAL TERMS OF SALE

CONDIZIONI GENERALI DI VENDIT | CONDITIONS GÉNÉRALES DE VENTE | TÉRMINOS GENERALES DE VENTA



1 CONTRACT REGULATIONS

These general conditions, subject to amendments or exceptions agreed in writing, regulate all sales contracts between RAK Ceramics Distribution Europe S.R.L. and the Purchaser.

Changes in the general terms of sale, quotations, credits or discounts given or granted by our agents or other brokers are not valid if not accepted in writing by authorised entities at our registered office. In any case, the general conditions in force at the time of contract signing are considered applicable.

These general conditions do not concern and do not regulate online sales of RAK Ceramics Distribution Europe S.R.L. products.

2 SCOPE OF THE SUPPLY

The supply includes only the materials, services and quantities specified in our order confirmation. The text of the RAK Ceramics Distribution Europe S.R.L. order confirmation will in any case supersede any other different quotation or order text.

3 ORDER CONFIRMATION

If individual elements of the RAK Ceramics Distribution Europe S.R.L. order confirmation contain differences with respect to previous agreements or to the order, the Purchaser who has not submitted a complaint within seven days of receiving our confirmation is understood to have accepted it as it was written. In particular, the unconditional acceptance of the order confirmation implies, by express contractual agreement, the acceptance of the general conditions listed in such order confirmation.

The customer undertakes to notify RAK Ceramics Distribution Europe S.R.L. of any change in the place of destination of the goods, if different from the venue mentioned in the order confirmation, no later than on the day scheduled for goods collection from RAK Ceramics Distribution Europe S.R.L., by sending, by post, fax or e-mail, the identification details of the recipient of the goods and/or of the required delivery destination. Failing such notification, the destination originally indicated is intended to be confirmed.

4 PRICES

The prices indicated in the RAK Ceramics Distribution Europe S.R.L. price lists are not binding: we therefore reserve the right to change them before accepting the order. The prices agreed for each individual sale are net amounts and refer to cash payments for delivery ex works, unless otherwise agreed in writing. If, between the ordering date (even after the order confirmation) and the delivery date, increases should intervene in the costs of raw materials, labour, fuel, production costs, transportation costs etc., RAK Ceramics Distribution Europe S.R.L. may increase the agreed price by giving written notice to the Purchaser also by fax or e-mail.

5 DELIVERY

Sales are always on an ex-works basis from RAK Ceramics Distribution Europe S.R.L.. The goods travel at the Purchaser's own risk and all our liability shall cease upon their handing over to the carrier, against whom the Purchaser, having performed the required checks, must file any complaints. Shipments, by sea or by land, for deliveries of supplies abroad, are made according to terms agreed from time to time, contained in the “Incoterms” approved by the International Chamber of Commerce.

6 DELIVERY TERMS

The terms of delivery are quoted for guidance only; any delays in delivery, interruptions, total or partial suspensions of supplies will not entitle to any indemnity or compensation for damages unless otherwise agreed in writing.

In any case, damages resulting from actions not attributable to RAK Ceramics Distribution Europe S.R.L. will not be refundable.

7 SAMPLES

The data, images, videos, etc., shown in the catalogues, in the illustrative, informative and/or advertising material of RAK Ceramics Distribution Europe S.R.L., as well as the characteristics of the samples and models sent by it to the Purchaser, have solely illustrative purposes and are not binding on

RAK Ceramics Distribution Europe S.R.L. These data have no binding value except to the extent that they have been expressly mentioned as binding in the offer or written acceptance by RAK Ceramics Distribution Europe S.R.L..

8 PAYMENTS

Invoices by RAK Ceramics Distribution Europe S.R.L. are issued on the day of the supply; the indicated net amounts must be paid upon the agreed deadline. Any and all payment obligations between the contracting parties must be fulfilled to the main office of RAK Ceramics Distribution Europe S.R.L.. Any payments made to agents, representatives or sale assistants of RAK Ceramics Distribution Europe S.R.L. shall not be deemed finalised until the corresponding amounts are received by RAK Ceramics Distribution Europe S.R.L..

Payment must be made, unless otherwise agreed in writing, at the time of delivery and to the designated banking institute of RAK Ceramics Distribution Europe S.R.L.. Any delay or irregularity in the payments gives RAK Ceramics Distribution Europe S.R.L. the right to suspend supplies and/or terminate the existing contracts, even if not related to the payments in question, as well as the right to compensation for any damages.

In any case, RAK Ceramics Distribution Europe S.R.L. has the right - starting from the payment due date and without a formal notice being needed - to default interest up to the extent provided for by the Italian Legislative Decree no. n. 231 dated 09/10/2002. Non-fulfilment, even if only partial, will result in an acceleration clause for the client; default interest on the unpaid amount will start to apply from the day of delivery, even if the payment deadline was agreed to be at a later date.

No dispute or controversy concerning the quality of the goods, faults or defects, and/or any other aspect of the contract may be taken into consideration, initiated and/or operated, unless after full payment of the price (solve et repete clause). Offsetting with any credits, however they may be arising, due by RAK Ceramics Distribution Europe S.R.L. is not allowed.

9 GUARANTEES AND CLAIMS

The quality of the ceramic material is defined on the basis of the current international regulations applicable to the corresponding product class.

RAK Ceramics Distribution Europe S.R.L. guarantees only the goods supplied as first choice material. Claims relating to goods of other grades than first choice (B choice, commercial, second, third, secondary or stock grades, etc.) will not be taken into consideration and/or accepted, nor is any implicit or explicitly guarantee granted on any such materials. The

Purchaser is requested to check the goods in terms of quality and quantity no later than

8 (eight) days from receiving them, otherwise all rights will be forfeited.

Any material that is found faulty must be kept available for RAK Ceramics Distribution Europe S.R.L. to carry out any checks that may be deemed appropriate; any further action (return, repair, or others) must be authorised in writing in advance. Complaints and requests of service under the guarantee after installation will not be considered and/or accepted if the claimed defects were obvious (e.g. dents, dimensional defects, differences in colour shades, etc.). Please note that first choice material may contain up to 5% defective tiles and that the colour shade of the material supplied may differ from the sample on display, since ceramic has an inherently variable appearance. Complaints regarding faults or hidden defects must be formally submitted in writing no later than 8 (eight) days after detection and, in any case, any action under the guarantee must be taken within one year after delivery, according to the law. The relevant notice must contain, in addition to the billing information, an accurate description of the defect, and an estimate of the product repair or modification costs; failing this information, the claim will not be accepted.

Should the claim be found groundless, the Purchaser will have to refund to RAK Ceramics Distribution Europe S.R.L. all expenses incurred to investigate the claim (travel, assessment, legal fees, etc.).

RAK Ceramics Distribution Europe S.R.L.'s obligation is, in any case, only limited to the replacement of defective parts or to their repairing, other claims being expressly excluded such as, but not limited to, any costs for removal and rearrangement of furniture, equipment, machinery, etc., lost profits due to down-time, inconvenience, indirect damage, etc. The presence of defective tiles does not affect the quality of the supply as a whole, nor does it

entail any obligation of replacement in full.

The time limit related to the duration of the guarantee is established by the Italian Civil Code.

10 RETENTION OF TITLE

The retention of title clause is applied to the sale of goods; therefore, in the event that payment, due to contractual agreements, must be made in whole or in part after delivery, the delivered products shall remain the property of RAK Ceramics Distribution Europe S.R.L. until full payment of their price.

11 CONTRACT TRANSFER

The purchaser may not assign the contract or any single obligations resulting from it without the written acceptance of RAK Ceramics Distribution Europe S.R.L.; also in this case, however, the Purchaser shall remain jointly liable with the assignee in regard to the assigned obligations.

12 INDUSTRIAL PROPERTY AND SELECTIVE DISTRIBUTION - LIMITS TO RESELLING

RAK Ceramics Distribution Europe S.R.L. is the owner and lawful holder of exclusive rights relating to trademarks, drawings and invention patents. In order to best guarantee the observance of the exclusive rights of RAK Ceramics Distribution Europe S.R.L., as well as to meet the expectations of end consumers regarding the expected quality, RAK Ceramics Distribution Europe S.R.L. manages its product supplies through a selective distribution system. The supplies received from RAK Ceramics Distribution Europe S.R.L. and its authorised selective sales points are intended for installation at the end user and no other form of re-sale to other commercial intermediaries other than end users is allowed, unless prior written authorisation is obtained from RAK Ceramics Distribution Europe S.R.L.. Any sale of goods in violation of this prohibition must therefore be considered not allowed and equated to the unlawful use of the industrial and intellectual property rights of RAK Ceramics Distribution Europe S.R.L., subject to the the right of RAK Ceramics Distribution Europe S.R.L. to request seizure of the goods from any holder.

In particular, it is forbidden to sell online and/or through similar distribution channels, unless this is previously authorised in writing by RAK Ceramics Distribution Europe S.R.L., as well as to sell to parties who use this distribution channel. A retailer who becomes aware of such sales practices must immediately suspend supplies and notify RAK Ceramics Distribution Europe S.R.L. in writing. Failing this, the retailer will be held jointly liable towards RAK Ceramics Distribution Europe S.R.L. for damages, indemnities etc.

RAK Ceramics Distribution Europe S.R.L. reserves the right to take legal action against anyone involved in unauthorised sales.

13 CONTRACT LAW - JURISDICTION

This contract is governed by the Italian law, including industry-specific common practice in the Province of Modena. For any dispute arising from the supply contract, initiated either by RAK Ceramics Distribution Europe S.R.L. or by the Purchaser, the Court of Modena shall have exclusive jurisdiction and any other court will be excluded.

In any case, RAK Ceramics Distribution Europe S.R.L. is entitled to bring cases before other judicial authorities.

14 SAFETY OF THE LOGISTIC CHAIN

RAK Ceramics Distribution Europe S.R.L., in order to guarantee international logistic safety, requires its customers to comply with standard requirements to guarantee the safety of contract goods and to ensure compliance with AEO - Authorized Economic Operator - Customs regulations throughout the European Community. The customers of RAK Ceramics Distribution Europe S.R.L. undertake to guarantee that the goods handed over or delivered are shipped or transported, stored, prepared and loaded in safe premises and in safe loading and shipping areas, protected against unauthorized tampering, using only authorized and appropriately trained internal personnel.

CONDITIONS GÉNÉRALES DE VENTE

CONDIZIONI GENERALI DI VENDIT | GENERAL TERMS OF SALE | TÉRMINOS GENERALES DE VENTA

CONDIZIONI GENERALI DI VENDITA

GENERAL TERMS OF SALE

TÉRMINOS GENERALES DE VENTA

TERMS AND CONDITIONS



1 DISPOSITIONS CONTRACTUELLES

Les conditions générales présentes, sous réserve de modifications et d’exceptions convenues par écrit, règlent tous les contrats de vente entre RAK Ceramics Distribution Europe S.R.L. et le client. Les variations des conditions générales de vente, les offres, les crédits ou les rabais accordés par nos agents ou autres intermédiaires, ne sont valables qu’acceptés par écrit par des personnes autorisées auprès de notre service juridique. Les conditions générales, valables au moment de la conclusion du contrat, s’appliquent dans tous les cas.

Les conditions générales présentes ne concernent ni ne règlent les ventes online des produits RAK Ceramics Distribution Europe S.R.L..

2 OBJET DE LIVRAISON

La livraison comprend uniquement les matériaux, les prestations et les quantités spécifiés dans notre confirmation de commande. Le texte de la confirmation de commande de RAK Ceramics Distribution Europe S.R.L. préjuge en tout cas du texte éventuellement différent de l’offre ou de la commande.

3 CONFIRMATION DE COMMANDE

S’il devait y avoir dans la confirmation de commande de RAK Ceramics Distribution Europe S.R.L., dans les éléments singuliers dont elle se compose, des différences par rapport aux conventions préalables ou à la commande, et que le client ne les conteste pas dans les 7 jours de la réception de notre confirmation, il est supposé qu’il l’a accepte telle qu’elle. En particulier, l’acceptation sans réserve de la confirmation de commande comprend, selon l’accord contractuel explicite, l’acceptation des conditions générales qui y sont reproduites.

Le client s’engage à communiquer à RAK Ceramics Distribution Europe S.R.L. le changement éventuel du lieu de livraison de la marchandise, dans le cas où il diffère de celui indiqué dans la confirmation de commande, et cela jusqu’au et non pas au-delà du jour prévu pour l’expédition auprès de RAK Ceramics Distribution Europe S.R.L., en communiquant, par poste, fax ou mail, les données personnelles du destinataire de la marchandise et/ou du lieu où elle devra être livrée. À défaut d’un tel communiqué, la destination indiquée à l’origine s’entend tacitement confirmée.

4 DÉLAIS DE LIVRAISON

Les prix indiqués sur les listes de RAK Ceramics Distribution Europe S.R.L. sont non contraignants: par conséquent, nous nous réservons le droit de les modifier avant l’acceptation de la commande. Les prix convenus pour chaque vente sont des prix nets, paiement comptant, livraison départ usine, sous réserve de toute convention écrite différente. S’il apparaît, entre la date de commande (même après la confirmation de commande) et la date de livraison, des augmentations concernant les coûts des matières premières, de la main-d’oeuvre, des combustibles, des coûts de production et de transport, etc., RAK Ceramics Distribution Europe S.R.L. pourra augmenter le prix convenu, en le communiquant au client, même par fax ou mail.

5 LIVRAISONS

La vente se fait toujours départ usine de RAK Ceramics Distribution Europe S.R.L.. Le transport de la marchandise s’effectue toujours aux risques et périls du destinataire et toute responsabilité de notre côté cesse par la livraison auprès de l’entreprise, vis-à-vis de laquelle, une fois les contrôles opportuns effectués, le client devra présenter d’éventuelles réclamations. Les transports, par voie maritime ou par voie de terre, qui concernent les livraisons à l’étranger, s’effectuent à la base de conditions définies d’une fois sur l’autre et citées dans les « incoterms », approuvés par la Chambre de commerce internationale.

6 CONDITIONS DE LIVRAISON

Les conditions de livraison sont d’un caractère approximatif, d’éventuels retards de livraison, des interruptions, des suspensions totales ou partielles des livraisons ne donnent lieu ni aux indemnités ni aux dédommagements, si rien d’autre n’a été convenu par écrit.

En aucun cas ne seront dédommagés des dégâts non imputables à RAK Ceramics Distribution Europe S.R.L..

7 ÉCHANTILLONS

Les données, les images, le matériel vidéo, etc., présentés dans les catalogues ainsi que dans le matériel illustratif, informatif et/ou publicitaire de RAK Ceramics Distribution Europe S.R.L., de même que les caractéristiques des échantillons et des modèles envoyés au client, sont uniquement d’un caractère illustratif, sans être affectés pour RAK Ceramics Distribution Europe S.R.L..

Ces données n’ont pas de valeur contraignante, sinon dans la mesure où elles étaient explicitement mentionnées comme telles dans l’offre ou dans l’acceptation écrite de RAK Ceramics Distribution Europe S.R.L..

8 PAIEMENTS

Les factures de RAK Ceramics Distribution Europe S.R.L. s’envoient le jour de la livraison et doivent être payées au net avant l’échéance du délai convenu. Toute obligation de paiement entre les partenaires contractuels doit être remplie auprès du siège de RAK Ceramics Distribution Europe S.R.L.. D’éventuels paiements effectués aux agents, représentants ou auxiliaires économiques de RAK Ceramics Distribution Europe S.R.L. ne sont pas considérés comme valables tant que les sommes respectives ne seront pas parvenues à RAK Ceramics Distribution Europe S.R.L.. Le paiement doit s’effectuer, sauf accord écrit contraire, à la suite de la livraison, auprès du l’institut bancaire indiqué par RAK Ceramics Distribution Europe S.R.L.. Tout retard ou toute irrégularité dans le paiement donne à RAK Ceramics Distribution Europe S.R.L. le droit de suspendre la livraison et/ou de résilier les contrats en cours, même si ceux-là ne concernent pas les paiements respectifs, de même que le droit à l’indemnisation d’éventuels dégâts. RAK Ceramics Distribution Europe S.R.L. a de toute façon le droit – de la date limite du délai de paiement, sans mise en demeure – aux intérêts de retard au montant prévu, selon d.lgs. 09/10/2002 n°. 231. Le manquement, même partiel, aura pour conséquence le déclin de la date du délai pour le client; les intérêts de retard sur la somme non payée commencent le jour de la livraison, même si le délai du paiement a été fixé ultérieurement.

Aucune contestation ou controverse concernant la qualité de la marchandise, des vices ou des défauts, et/ou n’importe quel autre aspect du contrat, ne peut être considérée, même si déjà initiée ou en cours, avant que le paiement intégral du prix ne soit versé. (clause solve et repete).

La compensation par d’éventuels crédits, de toute façon présents, n’est pas admise à l’égard de RAK Ceramics Distribution Europe S.R.L..

9 GARANTIES ET RÉCLAMATIONS

Les conditions de garantie de RAK Ceramics Distribution Europe S.R.L. sont régies par la loi italienne, y compris les usages du secteur de la Province de Modena. Pour toute controverse concernant le contrat de livraison, aussi bien da la part de RAK Ceramics Distribution Europe S.R.L. que de la part du client, est exclusivement compétent le tribunal de Modena, tout autre exclu. RAK Ceramics Distribution Europe S.R.L. a pourtant la possibilité de consulter d’autres autorités judiciaires.

10 RÉSERVE DE PROPRIÉTÉ

La vente de la marchandise s’effectue selon la clause de la réserve de propriété; si, par conséquent, selon une convention contractuelle, le paiement devait s’effectuer en tout ou en parties, après la livraison, les produits livrés restent dans la propriété de RAK Ceramics Distribution Europe S.R.L. jusqu’à ce que le prix entier soit payé.

11 RUPTURE DE CONTRAT

Le client ne peut céder ni le contrat ni certains rapports obligatoires qui en résultent, sans acceptation écrite du côté de RAK Ceramics Distribution Europe S.R.L.; et même dans ce cas-ci, le client en reste solidairement responsable avec la personne qui assume les obligations cédées.

12 PROPRIÉTÉ INDUSTRIELLE ET DISTRIBUTION SÉLECTIVE – LIMITES DE LA REVENTE

RAK Ceramics Distribution Europe S.R.L. est le titulaire et le détenteur légitime des droits exclusifs à la marchandise, aux dessins et aux brevets d’invention. Pour garantir le mieux possible le respect des droits exclusifs de RAK Ceramics Distribution Europe S.R.L., ainsi que les attentes des utilisateurs finaux par rapport aux propriétés qualitatives désirées, RAK Ceramics Distribution Europe S.R.L. administre les livraisons des propres produits par un système de distribution sélective. Les livraisons obtenues de RAK Ceramics Distribution Europe S.R.L. et de ses points de vente sélectifs autorisés sont destinées à l’installation auprès de l’utilisateur final, et il n’est permis aucune autre forme de la revente à d’ultérieurs intermédiaires commerciaux, autres que les utilisateurs finaux, sauf autorisation préalable sous forme écrite de la part de RAK Ceramics Distribution Europe S.R.L.. La revente de la marchandise, comme violation d’une telle interdiction, doit être considérée comme pas permise et comparable à l’usage illicite des droits de la propriété industrielle et intellectuelle de RAK Ceramics Distribution Europe S.R.L., avec le droit de RAK Ceramics Distribution Europe S.R.L. de revendiquer les biens séquestrés auprès de tout détenteur.

En particulier, est interdite la vente online et/ou la vente sur des canaux distributifs similaires et/ou analogues, sauf préalablement autorisée par écrit par RAK Ceramics Distribution Europe S.R.L., ainsi que la vente aux personnes qui font usage d’un tel canal distributif. Le revendeur qui serait informé sur de telles pratiques de vente, doit immédiatement suspendre

la livraison et aviser par écrit RAK Ceramics Distribution Europe S.R.L.. À défaut, il sera considéré comme solidairement responsable vis-à-vis de RAK Ceramics Distribution Europe S.R.L., par rapport aux dédommagements, aux dégâts et autre. RAK Ceramics Distribution Europe S.R.L. se réserve le droit de procéder juridiquement à l’égard de toute personne impliquée dans des reventes non autorisées.

13 DROIT CONTRACTUEL – COUR COMPÉTENTE

Le contrat est réglé par la loi italienne, y compris les usages du secteur de la Province de Modena. Pour toute controverse concernant le contrat de livraison, aussi bien da la part de RAK Ceramics Distribution Europe S.R.L. que de la part du client, est exclusivement compétent le tribunal de Modena, tout autre exclu. RAK Ceramics Distribution Europe S.R.L. a pourtant la

possibilité de consulter d’autres

autorités judiciaires.

14 SÉCURITÉ DU DÉROULEMENT LOGISTIQUE

Pour garantir la sécurité logistique internationale, RAK Ceramics Distribution Europe S.R.L. demande à ses propres clients le respect de standards exigés, pour garantir la sécurité des marchandises dans les rapports contractuels ainsi que leur conformité à la norme AEO – Operatore Economico Autorizzato – et aux règlements douaniers respectifs, dans toute l’Union Européenne. Les clients de RAK Ceramics Distribution Europe S.R.L. s’engagent à garantir que les marchandises prises en livraison ou livrées sont envoyées ou transportées,

entreposées, préparées et chargées en lieux sûrs et en zones de chargement et de transport sûres, ainsi que protégées contre des ruptures non autorisées, en n’employant que du personnel interne autorisé et opportunément instruit.

RAK CERAMICS | 2021

RAK CERAMICS | 2021

RAK CERAMICS | 2021

RAK CERAMICS | 2021

RAK CERAMICS | 2021

RAK CERAMICS | 2021

RAK CERAMICS | 2021

RAK CERAMICS | 2021

RAK CERAMICS | 2021

RAK CERAMICS | 2021

RAK CERAMICS | 2021

RAK CERAMICS | 2021

RAK CERAMICS | 2021

RAK CERAMICS | 2021

RAK CERAMICS | 2021

RAK CERAMICS | 2021

RAK CERAMICS | 2021

RAK CERAMICS | 2021

RAK CERAMICS | 2021

RAK CERAMICS | 2021

RAK CERAMICS | 2021

RAK CERAMICS | 2021

RAK CERAMICS | 2021

RAK CERAMICS | 2021

RAK CERAMICS | 2021

RAK CERAMICS | 2021

RAK CERAMICS | 2021

RAK CERAMICS | 2021

RAK CERAMICS | 2021

RAK CERAMICS | 2021

RAK CERAMICS | 2021

RAK CERAMICS | 2021

RAK CERAMICS | 2021

RAK CERAMICS | 2021

RAK CERAMICS | 2021

RAK CERAMICS | 2021

RAK CERAMICS | 2021

RAK CERAMICS | 2021

RAK CERAMICS | 2021

RAK CERAMICS | 2021

RAK CERAMICS | 2021

RAK CERAMICS | 2021

RAK CERAMICS | 2021

RAK CERAMICS | 2021

RAK CERAMICS | 2021

RAK CERAMICS | 2021

RAK CERAMICS | 2021

RAK CERAMICS | 2021

RAK CERAMICS | 2021

RAK CERAMICS | 2021

RAK CERAMICS | 2021

RAK CERAMICS | 2021

RAK CERAMICS | 2021

RAK CERAMICS | 2021

RAK CERAMICS | 2021

RAK CERAMICS | 2021

RAK CERAMICS | 2021

RAK CERAMICS | 2021

RAK CERAMICS | 2021

RAK CERAMICS | 2021

RAK CERAMICS | 2021

RAK CERAMICS | 2021

RAK CERAMICS | 2021

RAK CERAMICS | 2021

RAK CERAMICS | 2021

RAK CERAMICS | 2021

RAK CERAMICS | 2021

RAK CERAMICS | 2021

RAK CERAMICS | 2021

RAK CERAMICS | 2021

RAK CERAMICS | 2021

RAK CERAMICS | 2021

RAK CERAMICS | 2021

RAK CERAMICS | 2021

RAK CERAMICS | 2021

RAK CERAMICS | 2021

RAK CERAMICS | 2021

RAK CERAMICS | 2021

RAK CERAMICS | 2021

RAK CERAMICS | 2021

RAK CERAMICS | 2021

RAK CERAMICS | 2021

RAK CERAMICS | 2021

RAK CERAMICS | 2021

RAK CERAMICS | 2021

RAK CERAMICS | 2021

RAK CERAMICS | 2021

RAK CERAMICS | 2021

RAK CERAMICS | 2021

RAK CERAMICS | 2021

RAK CERAMICS | 2021

RAK CERAMICS | 2021

RAK CERAMICS | 2021

RAK CERAMICS | 2021

RAK CERAMICS | 2021

RAK CERAMICS | 2021

RAK CERAMICS | 2021

RAK CERAMICS | 2021

RAK CERAMICS | 2021

RAK CERAMICS | 2021

RAK CERAMICS | 2021

RAK CERAMICS | 2021

RAK CERAMICS | 2021

RAK CERAMICS | 2021

RAK CERAMICS | 2021

RAK CERAMICS | 2021

RAK CERAMICS | 2021

RAK CERAMICS | 2021

RAK CERAMICS | 2021

RAK CERAMICS | 2021

RAK CERAMICS | 2021

RAK CERAMICS | 2021

RAK CERAMICS | 2021

RAK CERAMICS | 2021

RAK CERAMICS | 2021

RAK CERAMICS | 2021

RAK CERAMICS | 2021

RAK CERAMICS | 2021

RAK CERAMICS | 2021

RAK CERAMICS | 2021

RAK CERAMICS | 2021

RAK CERAMICS | 2021

RAK CERAMICS | 2021

RAK CERAMICS | 2021

RAK CERAMICS | 2021

RAK CERAMICS | 2021

RAK CERAMICS | 2021

RAK CERAMICS | 2021

RAK CERAMICS | 2021

RAK CERAMICS | 2021

RAK CERAMICS | 2021

RAK CERAMICS | 2021

CONDIZIONI GENERALI DI VENDITA

GENERAL TERMS OF SALE

TÉRMINOS GENERALES DE VENTA

TERMS AND CONDITIONS



9 GARANTIES ET RÉCLAMATIONS

La qualité du matériel céramique se définit à la base de normes internationales en vigueur, qui s’appliquent à la classe de produits en question. RAK Ceramics Distribution Europe S.R.L. ne garantit que la seule marchandise de premier choix. Des réclamations concernant la marchandise de choix différent (choix B, choix économique, secondaire, tiers, stock, etc.) ne seront pas considérées et/ou acceptées, et aucun type de garantie n’est donné, implicitement ou explicitement, sur de tels matériaux. Le client est obligé de vérifier la marchandise par rapport à la qualité et la quantité, dans les 8 jours, et non pas au-delà, de la réception même ; après il n’en a plus aucun droit.

Le matériel considéré comme défectueux devra être mis à la disposition de RAK Ceramics Distribution Europe S.R.L., pour des contrôles considérés comme opportuns; toute action ultérieure (restitution, réparation ou autre) doit être autorisée en avance par écrit. Les réclamations et demandes en garantie après la pose ne seront pas considérées et/ou acceptées dans le cas où le défaut constaté se révèle évident (écaillages, défauts de taille, différences de tonalité, etc.) On précise que le premier choix peut contenir jusqu’à 5% de carreaux défectueux, et que la tonalité du matériel fourni peut différer de l’échantillon exposé, vu que la céramique est en soi variable dans son aspect.

Les réclamations en raison de défauts ou de vices occultes doivent être communiquées par écrit, dans les 8 jours de la découverte, et en tout cas, au bout d’un an après la livraison, selon la loi, tous les droits de garantie se prescrivent. Le communiqué devra contenir, à part les données de la facture, une description précise du vice, une estimation des coûts de réparation ou de modification du produit ; à défaut de ces données, la réclamation ne sera pas acceptée.

Dans le cas où la réclamation devrait s’avérer infondée, le client devra rembourser RAK Ceramics Distribution Europe S.R.L. de tous les coûts engendrés par les contrôles (voyages, avis consultatifs, frais juridiques, etc.)

L’obligation de RAK Ceramics Distribution Europe S.R.L. se limite, en tout cas, à substituer les seules pièces défectueuses ou à la réparation, et explicitement exclues en sont différentes indemnisations qui en résultent, comme, entre autres, les coûts d’évacuation ou le réaménagement du mobilier, de l’équipement, de machines, etc., la perte de gains d’interruptions ou d’arrêts de travail, des désagréments, des dégâts indirects, etc. La

présence de carreaux défectueux ni ne conteste la qualité de toute la livraison ni n’engage l’échange total.

Les limites temporelles de la garantie correspondent à celles convenues dans le code civil italien.

10 RÉSERVE DE PROPRIÉTÉ

La vente de la marchandise s’effectue selon la clause de la réserve de propriété; si, par conséquent, selon une convention contractuelle, le paiement devait s’effectuer en tout ou en parties, après la livraison, les produits livrés restent dans la propriété de RAK Ceramics Distribution Europe S.R.L. jusqu’à ce que le prix entier soit payé.

11 RUPTURE DE CONTRAT

Le client ne peut céder ni le contrat ni certains rapports obligatoires qui en résultent, sans acceptation écrite du côté de RAK Ceramics Distribution Europe S.R.L.; et même dans ce cas-ci, le client en reste solidairement responsable avec la personne qui assume les obligations cédées.

12 PROPRIÉTÉ INDUSTRIELLE ET DISTRIBUTION SÉLECTIVE – LIMITES DE LA REVENTE

RAK Ceramics Distribution Europe S.R.L. est le titulaire et le détenteur légitime des droits exclusifs à la marchandise, aux dessins et aux brevets d’invention. Pour garantir le mieux possible le respect des droits exclusifs de RAK Ceramics Distribution Europe S.R.L., ainsi que les attentes des utilisateurs finaux par rapport aux propriétés qualitatives désirées, RAK Ceramics Distribution Europe S.R.L. administre les livraisons des propres produits par un système de distribution sélective. Les livraisons obtenues de RAK Ceramics Distribution Europe S.R.L. et de ses points de vente sélectifs autorisés sont destinées à l’installation auprès de l’utilisateur final, et il n’est permis aucune autre forme de la revente à d’ultérieurs intermédiaires commerciaux, autres que les utilisateurs finaux, sauf autorisation préalable sous forme écrite de la part de RAK Ceramics Distribution Europe S.R.L.. La revente de la marchandise, comme violation d’une telle interdiction, doit être considérée comme pas permise et comparable à l’usage illicite des droits de la propriété industrielle et intellectuelle de RAK Ceramics Distribution Europe S.R.L., avec le droit de RAK Ceramics Distribution Europe S.R.L. de revendiquer les biens séquestrés auprès de tout détenteur.

En particulier, est interdite la vente online et/ou la vente sur des canaux distributifs similaires et/ou analogues, sauf préalablement autorisée par écrit par RAK Ceramics Distribution Europe S.R.L., ainsi que la vente aux personnes qui font usage d’un tel canal distributif. Le revendeur qui serait informé sur de telles pratiques de vente, doit immédiatement suspendre la livraison et aviser par écrit RAK Ceramics Distribution Europe S.R.L.. À défaut, il sera considéré comme solidairement responsable vis-à-vis de RAK Ceramics Distribution Europe S.R.L., par rapport aux dédommagements, aux dégâts et autre. RAK Ceramics Distribution Europe S.R.L. se réserve le droit de procéder juridiquement à l’égard de toute personne impliquée dans des reventes non autorisées.

13 DROIT CONTRACTUEL – COUR COMPÉTENTE

Le contrat est réglé par la loi italienne, y compris les usages du secteur de la Province de Modena. Pour toute controverse concernant le contrat de livraison, aussi bien da la part de RAK Ceramics Distribution Europe S.R.L. que de la part du client, est exclusivement compétent le tribunal de Modena, tout autre exclu. RAK Ceramics Distribution Europe S.R.L. a pourtant la

possibilité de consulter d’autres

autorités judiciaires.

14 SÉCURITÉ DU DÉROULEMENT LOGISTIQUE

Pour garantir la sécurité logistique internationale, RAK Ceramics Distribution Europe S.R.L. demande à ses propres clients le respect de standards exigés, pour garantir la sécurité des marchandises dans les rapports contractuels ainsi que leur conformité à la norme AEO – Operatore Economico Autorizzato – et aux règlements douaniers respectifs, dans toute l’Union Européenne. Les clients de RAK Ceramics Distribution Europe S.R.L. s’engagent à garantir que les marchandises prises en livraison ou livrées sont envoyées ou transportées,

entreposées, préparées et chargées en lieux sûrs et en zones de chargement et de transport sûres, ainsi que protégées contre des ruptures non autorisées, en n’employant que du

TÉRMINOS GENERALES DE VENTA

CONDIZIONI GENERALI DI VENDIT | GENERAL TERMS OF SALE | CONDITIONS GÉNÉRALES DE VENTE



1 REGLAMENTACIÓN DEL CONTRATO

Estas condiciones generales, sujetas a enmiendas o excepciones acordadas por escrito, regulan todos los contratos de venta entre RAK Ceramics Distribution Europe S.R.L. y el Comprador. Los cambios aportados a los términos generales de venta, a los precios, a los créditos o a los descuentos ofrecidos o garantizados por nuestros agentes o por otros comerciantes no son válidos en caso de no haber sido aceptados por escrito por entes autorizados en nuestra sede social.

De todas formas, las condiciones generales en vigor durante la firma del contrato se consideran aplicables. Estas condiciones generales no afectan y no regulan las ventas online de los productos de RAK Ceramics Distribution Europe S.R.L.

2 ALCANCE DEL SUMINISTRO
El suministro incluye solamente los materiales, los servicios y las cantidades que aparecen especificados en nuestra confirmación del pedido. En cualquier caso, el texto de la confirmación del pedido de RAK Ceramics Distribution Europe S.R.L. sustituye cualquier otro presupuesto diferente o texto de pedido.

3 CONFIRMACIÓN DEL PEDIDO

Cuando elementos individuales de la confirmación del pedido de RAK Ceramics Distribution Europe S.R.L. presentan diferencias respecto de los acuerdos previos o con el pedido, el Comprador, en caso de no haber enviado una reclamación en un plazo de siete días a contar a partir de la recepción de nuestra confirmación, acepta dicha confirmación como estaba escrita. En particular, la aceptación incondicional de la confirmación del pedido implica, por acuerdo contractual explícito, la aceptación de las condiciones generales enumeradas en dicha confirmación del pedido. El cliente se compromete a notificar a RAK Ceramics Distribution Europe S.R.L. todo cambio inherente al lugar de entrega de los productos, cuando no corresponda al lugar indicado en la confirmación del pedido, dentro del plazo del día programado para la recogida de los productos en RAK Ceramics Distribution Europe S.R.L., mediante el envío, por correo, fax o correo electrónico, de los detalles de identificación del/de la destinatario/a de los productos y/o del destino de entrega establecido. En caso de no producirse dicha notificación, el destino indicado en origen se considera confirmado.

4 PRECIOS
Los precios indicados en las listas de precios de RAK Ceramics Distribution Europe S.R.L. no son vinculantes: por consiguiente, nos reservamos el derecho de cambiarlos antes de aceptar el pedido. Los precios acordados para cada venta individual son importes netos y se refieren a pagos en efectivo para entrega franco fábrica, salvo en caso de acuerdo diverso por escrito. Cuando, entre la fecha de pedido (incluso después de la confirmación del pedido) y la fecha de entrega, se produzcan aumentos en los costes de materias primas, mano de obra, combustible, costes de producción, costes de transporte etc., RAK Ceramics Distribution Europe S.R.L. podrá aumentar el precio acordado informando por escrito al Comprador también por fax o correo electrónico.

5 ENTREGA
Las ventas se realizan siempre franco fábrica en RAK Ceramics Distribution Europe S.R.L. Los productos viajan bajo el riesgo del Comprador y nuestra responsabilidad cesa en el momento de la entrega de estos al transportista, contra el que el Comprador, después de efectuar los controles requeridos, habrá de cumplimentar las reclamaciones. Los envíos, marítimos o terrestres, para las entregas de los suministros en el extranjero, se realizan según los términos acordados en cada caso, contenidos en los “Incoterms” aprobados por la Cámara de Comercio Internacional.

6 TÉRMINOS DE ENTREGA
Los términos de entrega tienen un valor solamente indicativo; los retrasos en la entrega, las interrupciones, las suspensiones totales o parciales de los suministros no dan derecho a indemnizaciones o compensaciones por los daños salvo en caso de haberse acordado diversamente por escrito. En cualquier caso, los daños derivados de acciones no imputables a RAK Ceramics Distribution Europe S.R.L. no se reembolsarán.

7 MUESTRAS
Los datos, las imágenes, los vídeos, etc., que aparecen en los catálogos, en el material informativo, ilustrativo y/o publicitario de RAK Ceramics Distribution Europe S.R.L., así como también las características de las muestras y los modelos enviados por esta al Comprador, tienen solamente una finalidad ilustrativa y no son vinculantes para RAK Ceramics Distribution Europe S.R.L. Dichos datos no tienen un valor vinculante salvo en la medida en que hayan sido explícitamente mencionados como vinculantes en la oferta o en la aceptación escrita por RAK Ceramics Distribution Europe S.R.L.

8 PAGOS
RAK Ceramics Distribution Europe S.R.L. expide las facturas el día del suministro; los importes netos indicados se han de pagar en el plazo acordado. Todas y cada una de las obligaciones de pago entre las partes contratantes se han de cumplir en la sede principal de RAK Ceramics Distribution Europe S.R.L. Cualquier pago efectuado a agentes, representantes o vendedores de RAK Ceramics Distribution Europe S.R.L. no se ha considerar finalizado hasta que RAK Ceramics Distribution Europe S.R.L. reciba los correspondientes importes. Salvo en caso de acuerdo diverso por escrito, el pago se ha de efectuar durante la entrega y en instituto bancario indicado por RAK Ceramics Distribution Europe S.R.L. Los retrasos o las irregularidades en los pagos dan derecho a RAK Ceramics Distribution Europe S.R.L. a suspender los suministros y/o a finalizar los contratos existentes, incluso sin estar relacionados con los pagos en cuestión, y también tendrá derecho a pedir una compensación por los daños. En cualquier caso, RAK Ceramics Distribution Europe S.R.L. tiene derecho - a partir de la fecha de vencimiento del pago y sin necesitarse un requerimiento - a pedir los intereses de demora en la medida contemplada por el Decreto legislativo italiano n.º 231 con fecha del 09/10/2002. El incumplimiento, incluso solamente parcial, derivará en una cláusula de aceleración para el cliente; el interés de demora sobre el importe impagado empezará a aplicarse a partir del día de la entrega, incluso cuando el plazo de pago se hubiese acordado para una fecha posterior. Las disputas o controversias sobre la calidad de los productos, los desperfectos o los defectos, y/o inherentes a cualquier otro aspecto del contrato no se tomarán en consideración, iniciarán o actuarán sin que se haya efectuado el pago completo del precio (solve et repete clause). No se permite la compensación con créditos, a pesar de que pudieren surgir, debidos por RAK Ceramics Distribution Europe S.R.L.

9 GARANTÍAS Y RECLAMACIONES
La calidad del material cerámico se define sobre la base de las normas internacionales corrientes aplicables a la clase de producto correspondiente. RAK Ceramics Distribution Europe S.R.L. garantiza solamente los productos suministrados como material de primera calidad. Las reclamaciones, inherentes a productos de otras calidades, que no sean de primera calidad (calidad B, calidad comercial, segunda, tercera, secundaria o inventario, etc.), no se tomarán en consideración y/o aceptarán, ni se garantizará una garantía, implícita o explícita, para dichos materiales. El Comprador ha de controlar los productos en cuanto a calidad y cantidad dentro de un plazo de 8 (ocho) días a contar a partir de la recepción de estos, ya que de otro modo todos los derechos se perderán.

El material considerado defectuoso ha de permanecer disponible para RAK Ceramics Distribution Europe S.R.L. para efectuar todos los controles estimados apropiados; cualquier otra acción (devolución, reparación u otras) deben autorizarse por escrito por adelantado. Las reclamaciones y solicitudes de reparación en garantía después de la instalación no se considerarán y/o aceptarán cuando los defectos reclamados fueran obvios (por ejemplo, melladuras, defectos dimensionales, diferencias en tonos de color, etc.). Se ruega considerar que el material de primera calidad puede contener hasta el 5% de baldosas defectuosas y que el tono del color del material entregado puede ser diferente respecto de la muestra expuesta, ya que la cerámica presenta una apariencia variable por naturaleza. Las reclamaciones sobre desperfectos o defectos ocultos se han de enviar formalmente por escrito en un plazo de 8 (ocho) días después de la detección de estos y, en cualquier caso, toda acción en garantía se ha de efectuar en el plazo de un año después del suministro según establece la ley. Junto a la información de la factura, la notificación relevante ha de contener una descripción precisa del defecto y un cálculo de la reparación del producto o de los costes de modificación; a falta de dicha información, la reclamación no se aceptará. En caso de considerarse la reclamación sin fundamento, el Comprador habrá de devolver a RAK Ceramics Distribution Europe S.R.L. todos los gastos ocasionados para investigar la queja (viaje, valoración, gastos jurídicos, etc.). En cualquier caso, la obligación de RAK Ceramics Distribution Europe S.R.L. queda limitada solamente a la sustitución de las partes defectuosas o a la reparación de estas, excluyéndose explícitamente otras reclamaciones tales como, pero sin limitarse a estas, costes para desmontar o desplazar muebles, equipos, maquinarias, etc., lucro cesante por tiempo de inactividad, inconvenientes, daños indirectos, etc. La presencia de baldosas defectuosas no afecta la calidad del suministro en su totalidad, ni conlleva la obligación de su sustitución completa El código civil italiano determina el tiempo límite de duración de la garantía.

10 RESERVA DE DOMINIO
La cláusula de reserva de dominio se aplica a la venta de productos; por consiguiente, en caso de que el pago, establecido en los acuerdos contractuales, tenga que efectuarse en su totalidad o parcialmente después de la entrega, los productos entregados siguen siendo propiedad de RAK Ceramics Distribution Europe S.R.L. hasta el pago completo del precio de estos.

11 TRANSMISIÓN DEL CONTRATO A UN TERCERO
El comprador no puede asignar el contrato o las obligaciones individuales derivadas de este sin contar con la aceptación por escrito de RAK Ceramics Distribution Europe S.R.L.; sin embargo, también en dicho caso, el Comprador sigue siendo responsable junto al beneficiario en cuanto a las obligaciones asignadas

12 PROPIEDAD INDUSTRIAL Y DISTRIBUCIÓN SELECTIVA - LÍMITES DE REVENTA
RAK Ceramics Distribution Europe S.R.L. es el propietario y el titular legítimo de los derechos exclusivos acerca de marcas comerciales, planos y patentes de invención. Con el fin de garantizar de la forma mejor el respeto de los derechos exclusivos de RAK Ceramics Distribution Europe S.R.L. y, asimismo, satisfacer las expectativas de los consumidores finales en cuanto a la calidad esperada, RAK Ceramics Distribution Europe S.R.L. gestiona las entregas de sus productos a través de un sistema de distribución selectiva. Los suministros recibidos de RAK Ceramics Distribution Europe S.R.L. y sus puntos de venta selectivos autorizados se consideran para la instalación en la casa del usuario final y no otra forma de venta a otros intermediarios comerciales aparte de los usuarios finales queda autorizada, salvo en caso de contar con una autorización escrita previa de RAK Ceramics Distribution Europe S.R.L. Por consiguiente, la venta de productos que no respete esta prohibición se ha de considerar no permitida y equiparada a un uso ilegal de los derechos de propiedad e industriales de RAK Ceramics Distribution Europe S.R.L., sujeta al derecho de RAK Ceramics Distribution Europe S.R.L. de solicitar el embargo de los productos entregados a cualquier poseedor. RAK Ceramics Distribution Europe S.R.L. se reserva el derecho de emprender acciones legales contra toda persona implicada en ventas no autorizadas.

13 DERECHO CONTRACTUAL - JURISDICCIÓN
Este contrato se rige por la ley italiana, incluyéndose las disposiciones legales específicas industriales en la provincia de Modena. Para las controversias derivadas del contrato de suministro, entabladas por RAK Ceramics Distribution Europe S.R.L. o por el Comprador, el Tribunal de Modena habrá la jurisdicción exclusiva quedando excluidos otros tribunales. En cualquier caso, RAK Ceramics Distribution Europe S.R.L. tiene derecho a recurrir a otras autoridades judiciales.

14 SEGURIDAD DE LA CADENA DE LOGÍSTICA
Con el fin de garantizar la seguridad de la logística internacional, RAK Ceramics Distribution Europe S.R.L. pide a sus clientes cumplir los requisitos estándares para garantizar la seguridad de los productos del contrato y asegurar el cumplimiento de AEO - Operador económico autorizado - Reglamentación aduanera en la Comunidad Europea. Los clientes de RAK Ceramics Distribution Europe S.R.L. se comprometen a garantizar que los productos transferidos o entregados se envían o transportan, almacenan, preparan o cargan en instalaciones seguras y en áreas seguras de carga y envío, protegidas contra manipulaciones no autorizadas, recurriendo solamente a personal interno autorizado y formado adecuadamente.

TECHNICAL MANUAL

Technical specifications - Porcelain Tiles (natural)

TEST DESCRIPTION	STANDARD TEST METHOD	STANDARD REQUIREMENTS	RAK CERAMICS SPECIFICATION
Surface Quality	BS EN ISO 10545-2	a minimum of 95% of the tiles are to be free from visible defects	Minimum of 95% of the tiles are free from visible defects
Length & Width	BS EN ISO 10545-2	± 1.0mm	± 0.1mm
Thickness	BS EN ISO 10545-2	± 0.5mm	± 0.5mm
Straightness Of Sides	BS EN ISO 10545-2	± 0.8mm	± 0.8mm
Rectangularity	BS EN ISO 10545-2	± 1.5mm	± 1.2mm
Surface Flatness: Centre Curvature	BS EN ISO 10545-2	± 1.8mm	± 1.8mm
Surface Flatness: Edge Curvature	BS EN ISO 10545-2	± 1.8mm	± 1.5mm
Surface Flatness: Warpage	BS EN ISO 10545-2	± 1.8mm	± 1.5mm
Water Absorption	BS EN ISO 10545-3	≤ 0.5%	≤ 0.4%
Breaking Strength*	BS EN ISO 10545-4	≥ 700 N	≥ 700 N
Modulus Of Rupture*	BS EN ISO 10545-4	≥ 35 N/mm ²	≥ 35 N/mm ²
Resistance To Surface Abrasion	BS EN ISO 10545-7	Report abrasion class	PEI CLASS 2-4
Coefficient Of Linear Thermal Expansion	BS EN ISO 10545-8	Test method available	≤ 7 X 10 ⁻⁶ /oC
Resistance To Thermal Shock	BS EN ISO 10545-9	Test method available	No visible defect
Crazing Resistance	BS EN ISO 10545-11	Required	No crazing
Frost Resistance	BS EN ISO 10545-12	Required	No visible damage
Resistance To Household Chemicals & Swimming Pool Salts	BS EN ISO 10545-13	Minimum Class B	Class A No visible effect
Resistance To Low Concentrations Acids & Alkalis	BE EN ISO 10545-13	Manufacturer to state classification	Class LA No visible effect
Resistance To Staining	BS EN ISO 10545-14	Minimum Class 3	Min. Class 4 Stains removed

Note: This technical specifications are applicable only to tiles in choice "A".

* Test performed using 60X60 cm cut pieces from the slab.
* Thickness is nominal

Packaging details

TILE THICKNESS: 6MM

TILE SIZE (CM)	TILE AREA (sqm)	KG per pc	PCS per pallet	TILE AREA per pallet (sqm)	WEIGHT per pallet (kg)
120x260	3.12	44	20	62.4	960
120x260	3.12	44	20	62.4	960

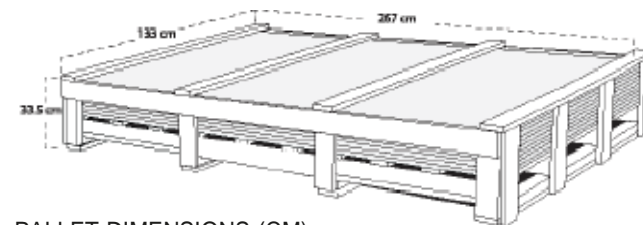

PALLET DIMENSIONS (CM)

LENGTH	HEIGHT	WIDTH
267	33.5	133
267	33.5	133

TECHNICAL MANUAL

Suggested equipment

HANDLING EQUIPMENT	CUTTING AND DRILLING EQUIPMENT
Aluminum Parallel profile with crossbars and Suction Vacuum suction cups with vacuum gauge	Compass device with suction cups for Circular Cuts
Tile Cart Trolley	Free cut guide with complete outfit Max. Cut of length – 156 cm
Double Suction Cups	Free Cut Extension
Modular Work Bench BM180	Cutting off pliers for tile/slabs
Modular Work Bench BM180 BM180 Plus (Perfect Workstation for large format tiles up to 160cm width)	Diamond polishing pad
	Diamond for edge and side polishing
	Diamond Blades for simultaneous cutting and grooving
INSTALLATION AND LEVELLING EQUIPMENT	CLEANING AND MAINTENANCE
Compact Vibrator or Tile Beater	Brooms
RLS 3D Clips for tiles	Floats with abrasive pads
Wedges (for Anti-Chipping / Anti-Scratching preventing platforms)	
Adjustable pliers for wall and floor covering	
Low-speed mixer	
Rubber Grout floats	
Slant ridge notched trowel	
Diamond for edge and side polishing	

Handling Maximus

- Maximus extra-large format slabs arrive in oversized crates, which require specific Handling equipment to prevent from damage occurring during forklift operation, specific fork sizes must be used. For example, to handle a crate of 135cm x 305cm tiles from the side, 112cm/ 44" long forks are recommended.
- To handle the same crate from the narrow end requires forks that are at least 213cm/ 84" long. Lifting multiple crates with longer forks may require forklifts with a greater lift capacity.
- Specialized tools and equipment are currently available for the handling, installation and cutting of large porcelain surfaces. Innovative trowels with unique notch configurations can help increase the consistency of the mortar coverage on the back of the tile.
- To increase rigidity and limit twisting, use a system composed of parallel and transverse guides.
- For a perfect adhesion clean the slab and the suckers with a damp sponge.
- The suckers run along the guides and adhere to the slab. Make sure that a vacuum is created between the device and the surface.
- A single guide device can be used for sizes of maximum length.
- Use four operators at a time to carry out handling operations of large size slabs.
- Lift the slab along the long side and hang it vertically to the handles of the frame.
- For the large size slab a suitably reinforced trolley is recommended. Set the guides to the trolley for carrying the slab.
- Follow the same procedure for handling the 120x240cm and all other sub-sizes, where only two operators are sufficient.

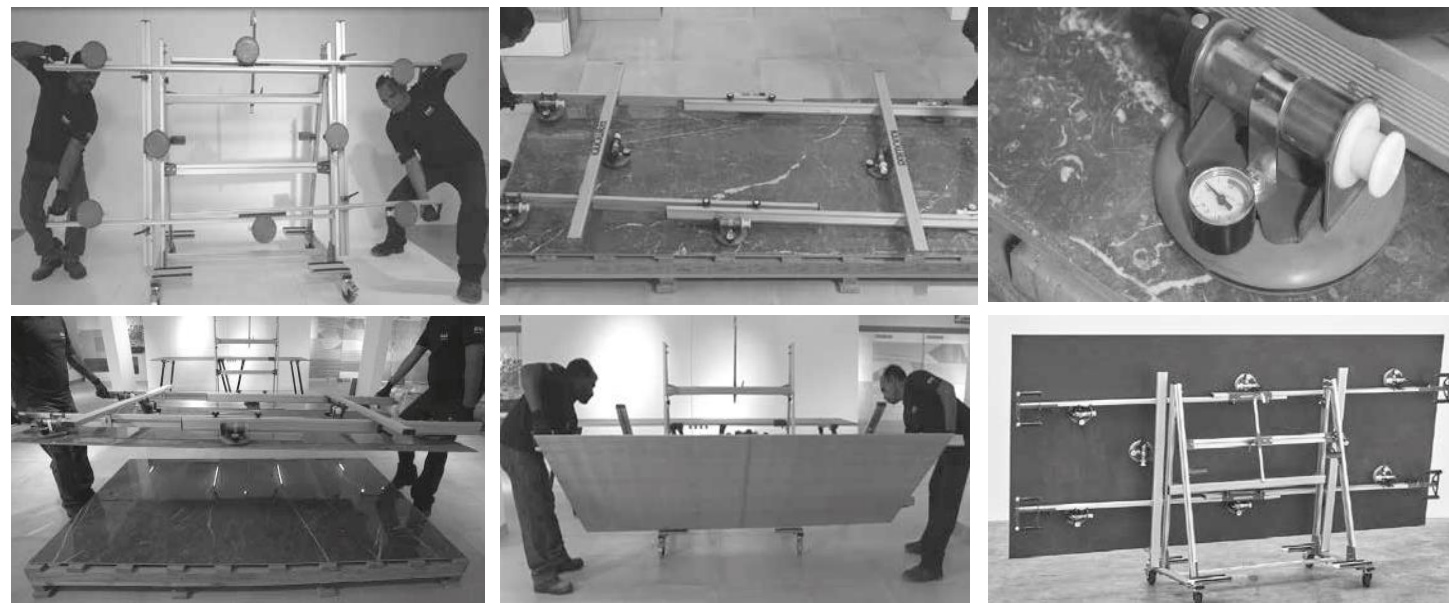
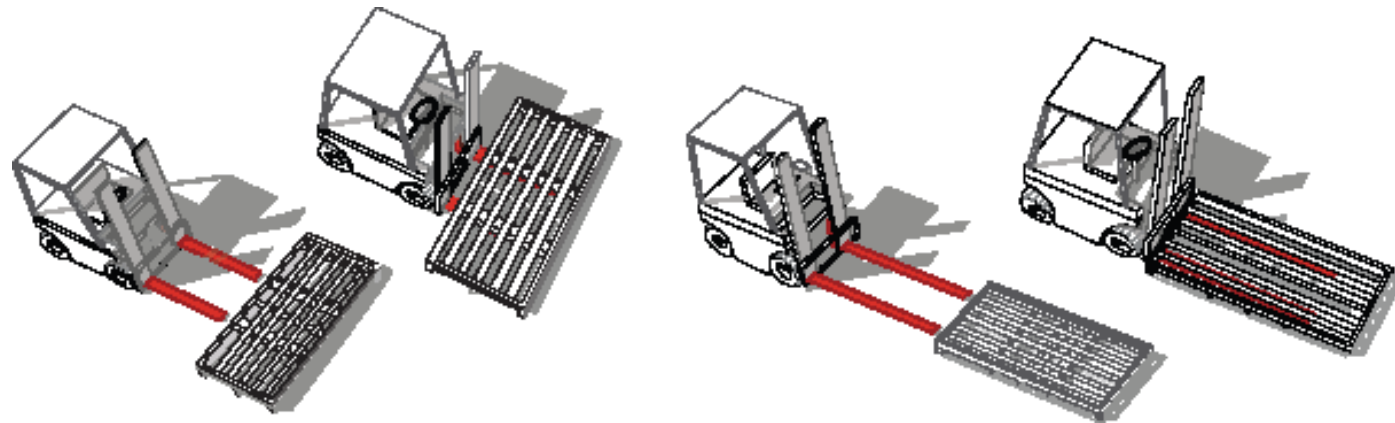







Cut-to-pieces and drilling

- RAK Ceramics recommends the use of special designed devices for handling as well as cutting and laying of big slabs.
- Handle slab with a proper and professional trolley of aluminum parallel profile with crossbars and vacuum suction cups along with a vacuum gauge. Please use double suction cups for slabs above 300cm. This could make sure that appropriate vacuum is created between the device and the slab. Lift the slab and keep it vertically to the trolley frame.
- Keep the slab on a stable, flat and intractable surface. For successful cutting and drilling, RAK Ceramic recommend using a professional modular workbench with aluminum profiles and proper cutting tools for each type of cut.
- Set the cutting unit on the tile so that the references coincide with the marked lines and lock it with the appropriate suckers. Score the slab from one edge to the other, being carefully maintaining the same pressure while moving.
- When the cut has been made, move the slab until the slit line sticks out a 10 to 15 cm from the workbench. Start hew from both sides using appropriate cutting-off pliers and follow the scoring line to complete the hew.
- Smooth rough edges and sides with an appropriate diamond polishing pad.
- To drill internal cutouts from the slab, first you need to draw the guide lines. For circular cuts, use the compass device with suction cups. For rectangular cut, drill first a 5 – 7 mm hole at the corners of the rectangle shape, using a non-percussion drill. For a better drilling always, keep the surface and drill a little bit wet. Then Follow the drilled lines using a diamond-blade angle grinder and then finish off the edges with a diamond-polishing pad. Round holes (4) must be made in wet drilling, using diamond-blades. Start engraving the surface with a 75 degrees point angle, then straighten out the drill avoiding excessive pressure on the slab. Also, in this case finish with a diamond-polishing pad.
- Manual traction devices are available, in order to make a finishing cut at 45° and thus enable special applications of the material.



R RATING TABLE

Collezioni Collections Collections Colecciones	Tipologia Typology Typologie Tipologia	Colori Colours Couleurs Colores	R 	R 	R 
Basic Concrete	Gres porcellanato Porcelain tiles Carreaux en grès cérame Porcelánico	Grey	R9	-	-
		Beige	R9	-	-
		Dark Grey	R9	-	-
		Dark Beige	R9	-	-
Cementina	Gres porcellanato Porcelain tiles Carreaux en grès cérame Porcelánico	Grey	R9	-	-
		Beige	R9	-	-
		Anthracite	R9	-	-
Circle Wood	Gres porcellanato Porcelain tiles Carreaux en grès cérame Porcelánico	Grey	R10 / A+B	-	-
		Grey	R10 / A+B	-	-
		Nut	R10 / A+B	-	-
		Beige	R10 / A+B	-	-
		Brown	R10 / A+B	-	-
City Stone	Gres porcellanato Porcelain tiles Carreaux en grès cérame Porcelánico	Bone	R10 / A	-	-
		Grey	R10 / A	-	-
		Anthracite	R10 / A	-	-
		Clay	R10 / A	-	-
Curton	Gres porcellanato a tutta massa Full body porcelain tiles Grès cérame plein masse Porcelánico todo masa High Performance Technical Product	White	R10 / A+B	-	R11 / A+B (Decors only)
		Taupe	R10 / A+B	-	R11 / A+B (Decors only)
		Grey	R10 / A+B	-	R11 / A+B (Decors only)
		Beige	R10 / A+B	-	R11 / A+B (Decors only)
Detroit Metal	Gres porcellanato Porcelain tiles Carreaux en grès cérame Porcelánico	Beige	-	R9 / A	-
		Brown	-	R9 / A	-
		Taupe	-	R9 / A	-
		Light Grey	-	R9 / A	-
		Grey	-	R9 / A	-
Evoque Metal	Gres porcellanato Porcelain tiles Carreaux en grès cérame Porcelánico	Ice	R10 / A	R9 / A	-
		Grey	R10 / A	R9 / A	-
		Green Blue	R10 / A	R9 / A	-
		Brown	R10 / A	R9 / A	-
		Ivory	R10 / A	-	R11 / A+B
Line Wood	Gres porcellanato Porcelain tiles Carreaux en grès cérame Porcelánico	Beige	R10 / A	-	R11 / A+B
		Dark Beige	R10 / A	-	R11 / A+B
		Brown	R10 / A	-	R11 / A+B
		Dark Brown	R10 / A	-	R11 / A+B
		Grey	R9 / A	-	R11 / A+B (30x60, 60x60 & 100x100)
Lounge	Gres porcellanato a tutta massa Full body porcelain tiles Grès cérame plein masse Porcelánico todo masa High Performance Technical Product	Cold Anthracite	R9 / A	-	R11 / A+B (30x60, 60x60 & 100x100)
		Anthracite	R9 / A	-	R11 / A+B (30x60, 60x60 & 100x100)
		Dark Anthracite	R9 / A	-	R11 / A+B (30x60, 60x60 & 100x100)
		Black	R9 / A	-	R11 / A+B (30x60, 60x60 & 100x100)
		Ivory	R9 / A	-	R11 / A+B (30x60, 60x60 & 100x100)
		Light Grey	R9 / A	-	R11 / A+B (30x60, 60x60 & 100x100)
		Beige	R9 / A	-	R11 / A+B (30x60, 60x60 & 100x100)
		Beige Brown	R9 / A	-	R11 / A+B (30x60, 60x60 & 100x100)

Collezioni Collections Collections Colecciones	Tipologia Typology Typologie Tipologia	Colori Colours Couleurs Colores	R 	R 	R 
Maremma	Gres porcellanato Porcelain tiles Carreaux en grès cérame Porcelánico	Steel	R10 / A	-	-
		Grey	R10 / A	-	-
		Sand	R10 / A	-	-
		Dark Brown	R10 / A	-	-
		Copper	R10 / A	-	-
		Orange	R10 / A	-	-
		Cotto	R10 / A	-	-
Select Wood	Gres porcellanato Porcelain tiles Carreaux en grès cérame Porcelánico	Ice	R10 / A	-	-
		Bone	R10 / A	-	-
		Nut	R10 / A	-	-
		Oak	R10 / A	-	-
		Brown	R10 / A	-	-
		Dark Brown	R10 / A	-	-
		Cool Grey	R10 / A+B	-	-
Surface 2.0	Gres porcellanato Porcelain tiles Carreaux en grès cérame Porcelánico	Mid Grey	R10 / A+B	-	-
		Ash	R10 / A+B	-	-
		Night	R10 / A+B	-	-
		Off White	R10 / A+B	-	-
		Clay	R10 / A+B	-	-
		Charcoal	R10 / A+B	-	-
		Sand	R10 / A+B	-	-
		Light Sand	R10 / A+B	-	-
		Greige	R10 / A+B	-	-
		Dark Greige	R10 / A+B	-	-
		Copper	R10 / A+B	-	-
		Mid Grey	-	-	R11 / A+B (20mm thickness)
		Ash	-	-	R11 / A+B (20mm thickness)
Night	-	-	R11 / A+B (20mm thickness)		
Cool Grey	-	-	R11 / A+B (20mm thickness)		
Surface 2.0 Outdoor	Gres porcellanato Porcelain tiles Carreaux en grès cérame Porcelánico	Sand	-	-	R11 / A+B (20mm thickness)
		Copper	-	-	R11 / A+B (20mm thickness)
		Charcoal	-	-	R11 / A+B (20mm thickness)
		Grey	-	-	-
Tokyo Concrete	Gres porcellanato a tutta massa Full body porcelain tiles Grès cérame plein masse	Grey	-	-	-



LE CERAMICHE DI GIOVANNI
PIAZZA RE UMBERTO PRIMO
89044 LOCRI (RC)
TEL 3272454833